



What does a Ranger and a Basdard on Mount Graham?

Linc Nirvana Software Development

Florian Briegel
Udo Neumann (VLT)
Jürgen Berwein, Frank Kittmann (Linc Nirvana)
Jose Borelli, Martin Kulas (Argos)
Richard J. Mathar (NIR Detector)
Alexey Pavlov (Linc Nirvana/Sphere)





NIRCS

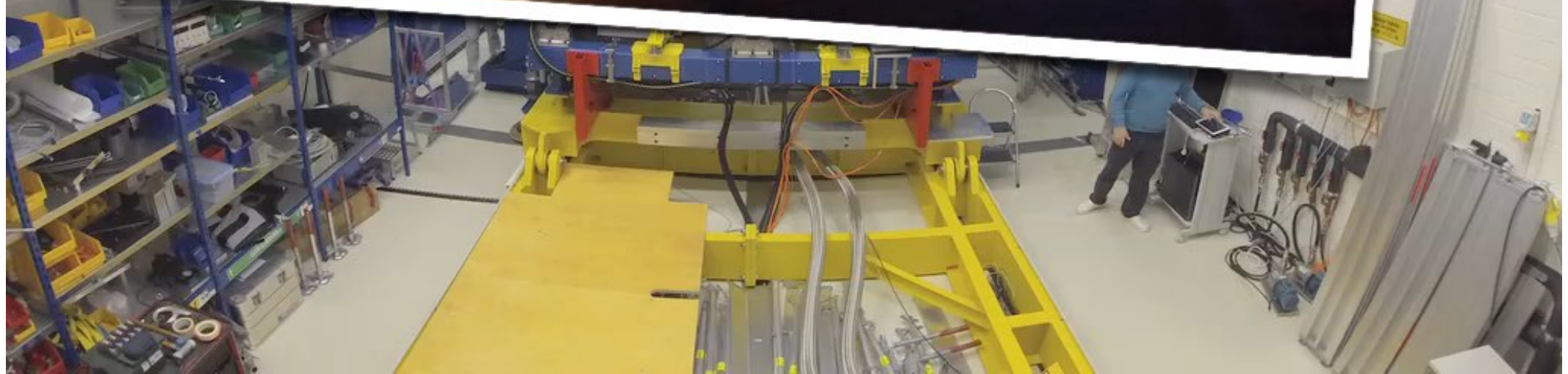

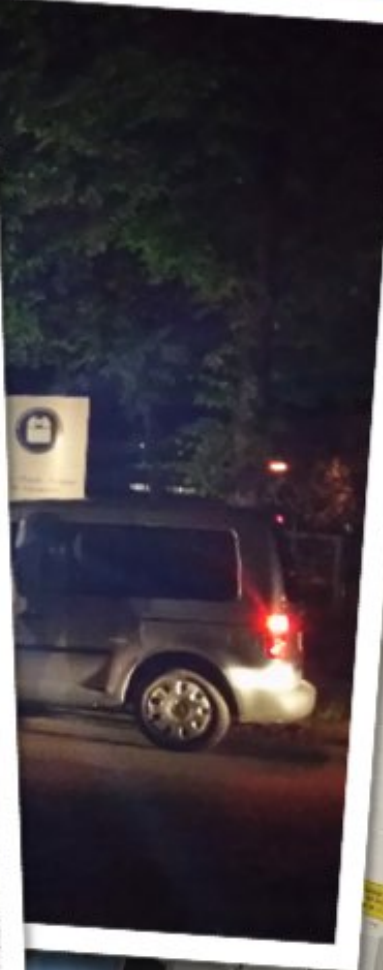
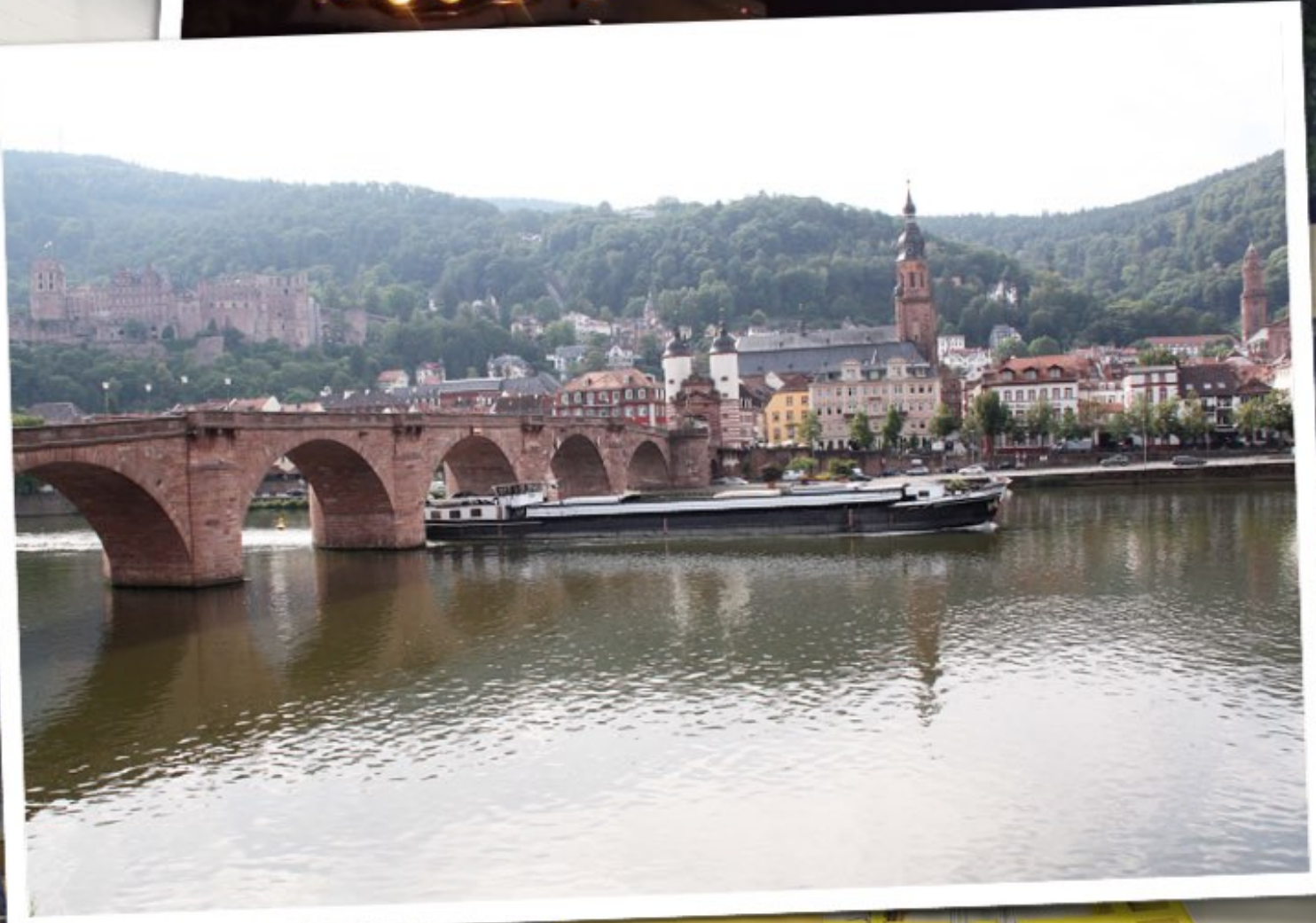

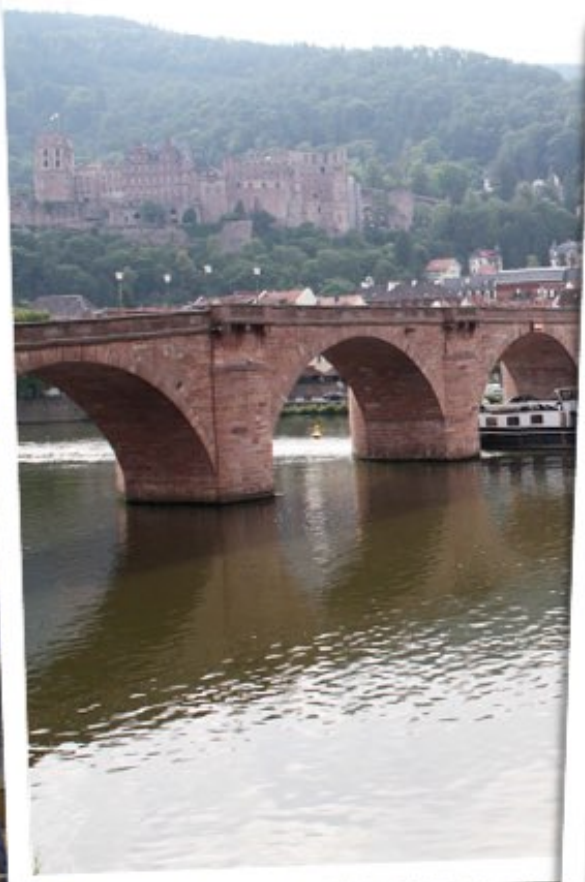
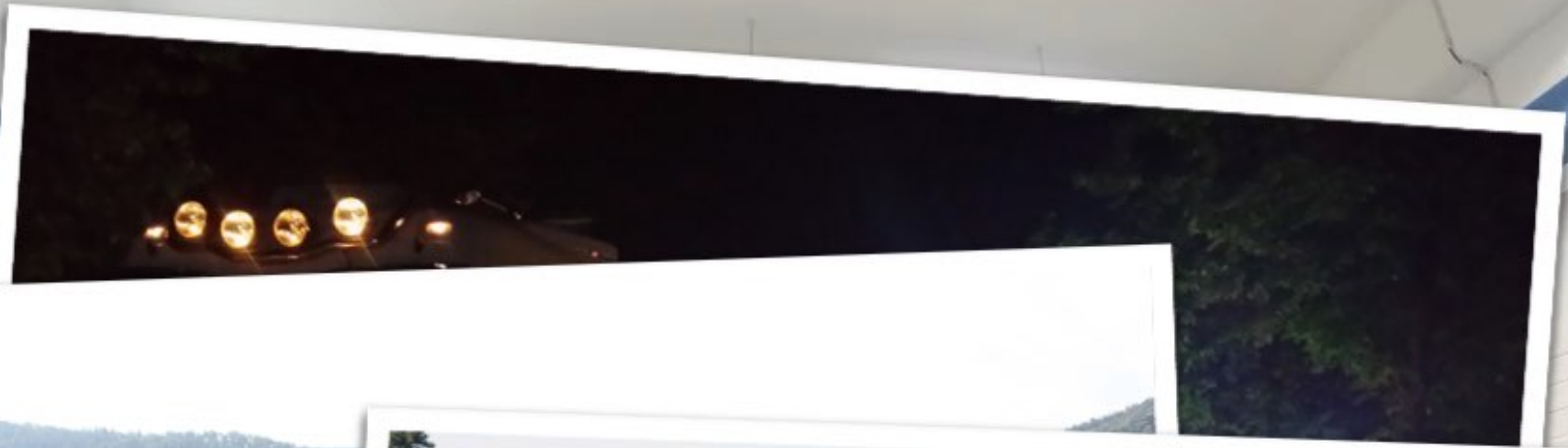

N08°15'47.18"
W079°05'22.04"
(09 2631, -079 9228)

Simple Map Satellite

NYK DIANA

3 Manuel Dominguez
@marinetraffic.com

Ship Type:
Container Ship

Flag:
Panama

Length x Breadth:
295m x 33m

CALL SIGN:
3E054

IMO:
9337688

MMSI:
372119000

Received:
8 min ago
(AIS Source: 5031)

Status:
Stopped

Speed/Course:
0.0kn / 166°

Destination:
US LAX

ETA:
2015-10-16 17:00 (UTC)

- Show Previous Track
- Distance to...
- Itineraries History
- Position History
- Port Calls
- Nearby Vessels

OFF ON SAT

Vessel Details >

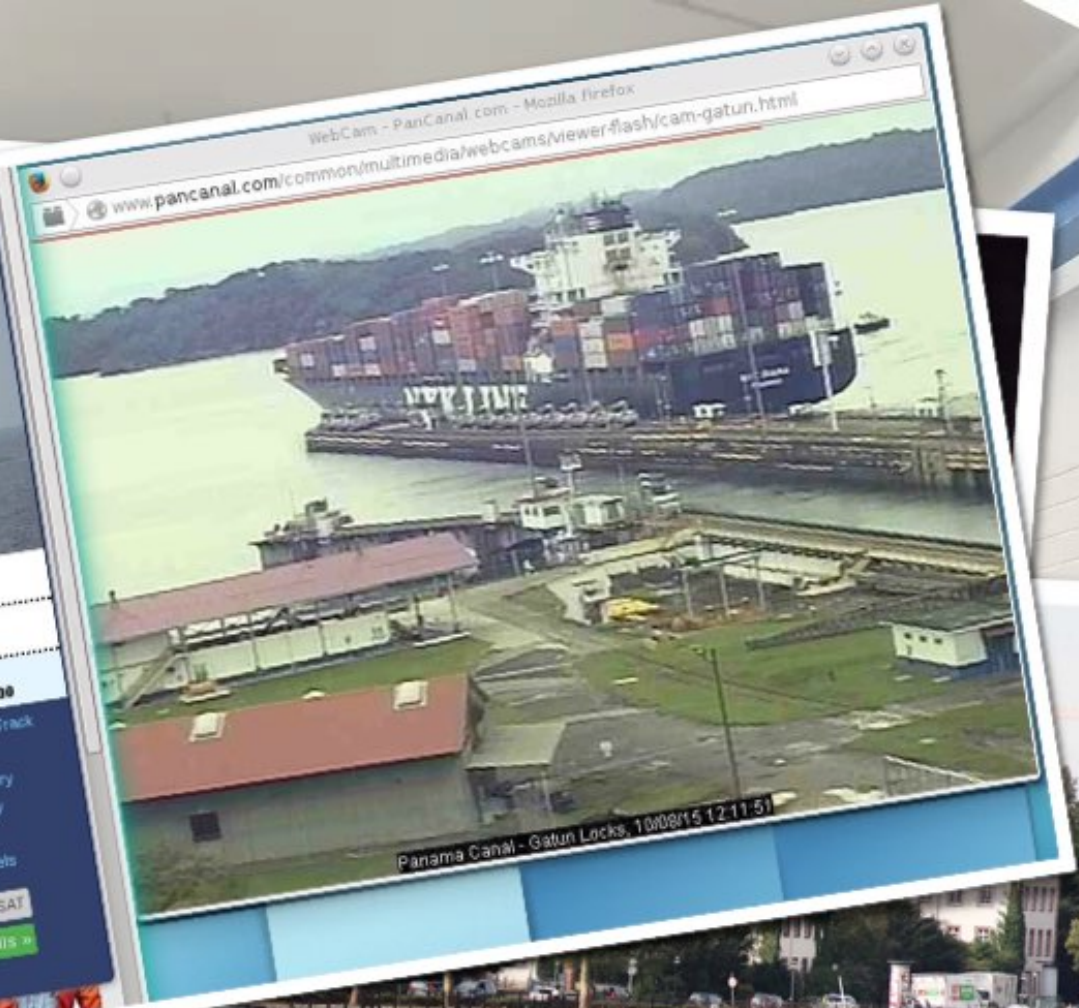

N03°15'47.18"
W079°05'22.04"
(89 2631, -

Simple Map Satellite

NYK DIANA

WebCam - PanCanal.com - Mozilla Firefox
www.pancanal.com/common/multimedia/webcams/viewer-flash/cam-gatun.html



UNDINE



Flag: Sweden
Length x Breadth: 228m x 33m
CALL SIGN: SHJC
IMO: 9240160
MMSI: 265804000
Ship Type: Vehicles Carrier
Draft: 9.8m

Received: 7 min ago
(AIS Source: 2958)
Status: Underway using Engine
Speed/Course: 13kn / 184°
Destination: PANAMA CANAL
ETA: 2015-10-06 06:00 (UTC)

- Show Vessel's Track
- Distance to...
- Itinerary History
- Position History
- Port Calls
- Nearby Vessels

[Add to Fleet](#)
[Vessel's Details](#)

Mitsegeln auf großer
Klassik-Yacht mit
Service & Komfort à la
Kreuzfahrt!

WebCam - PanCanal.com - Mozilla Firefox <2>
www.pancanal.com/common/multimedia/webcams/viewer-flash/cam-gatun.html



Panama Canal - Gatun Lock



WebCam - PanCanal.com - Mozilla Firefox
www.pancanal.com/common/multimedia/webcams/viewer-flash/cam-gatun.html

N08°15'47.11
W079°05'22.11
(08 2631, -4





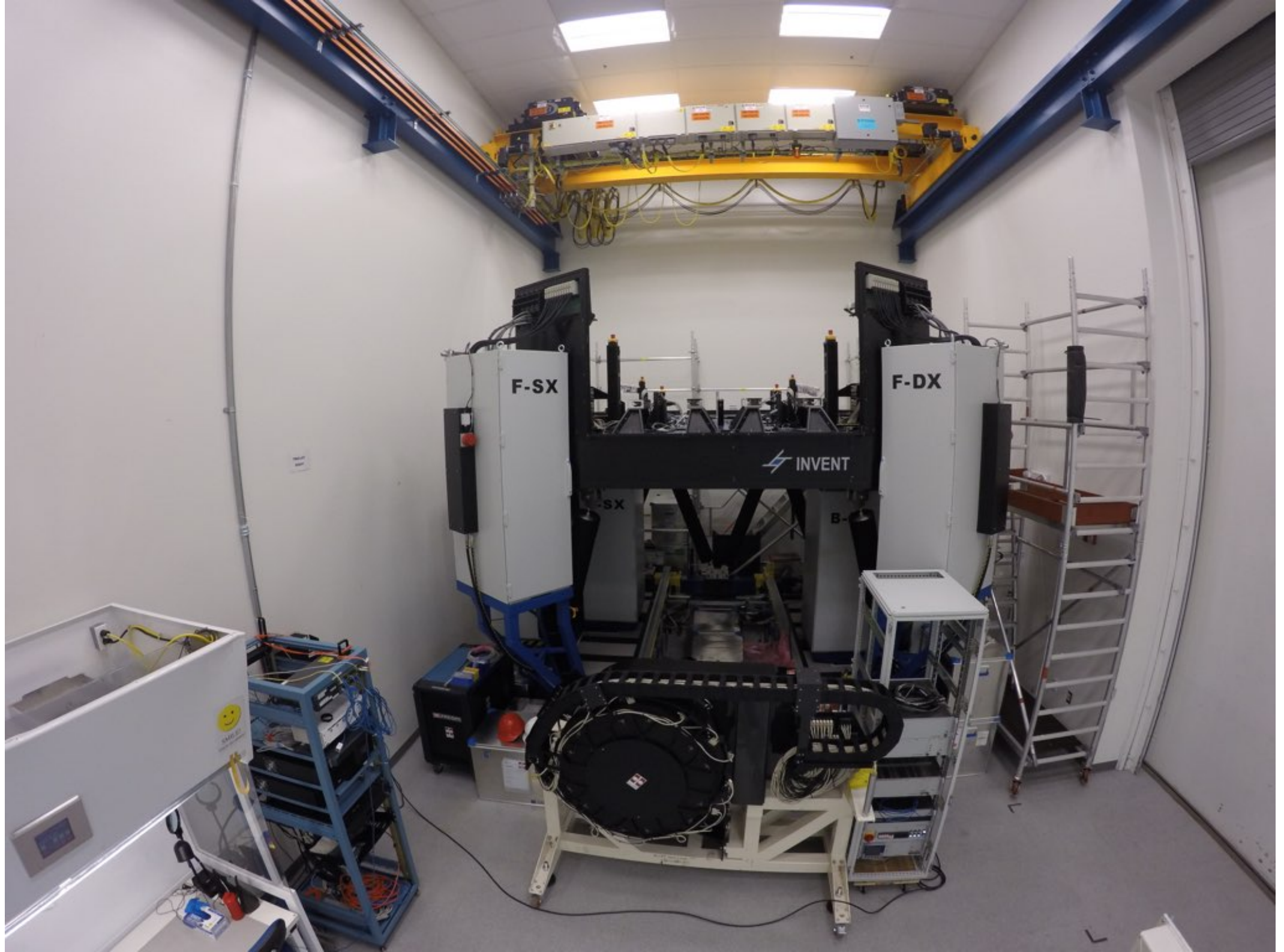

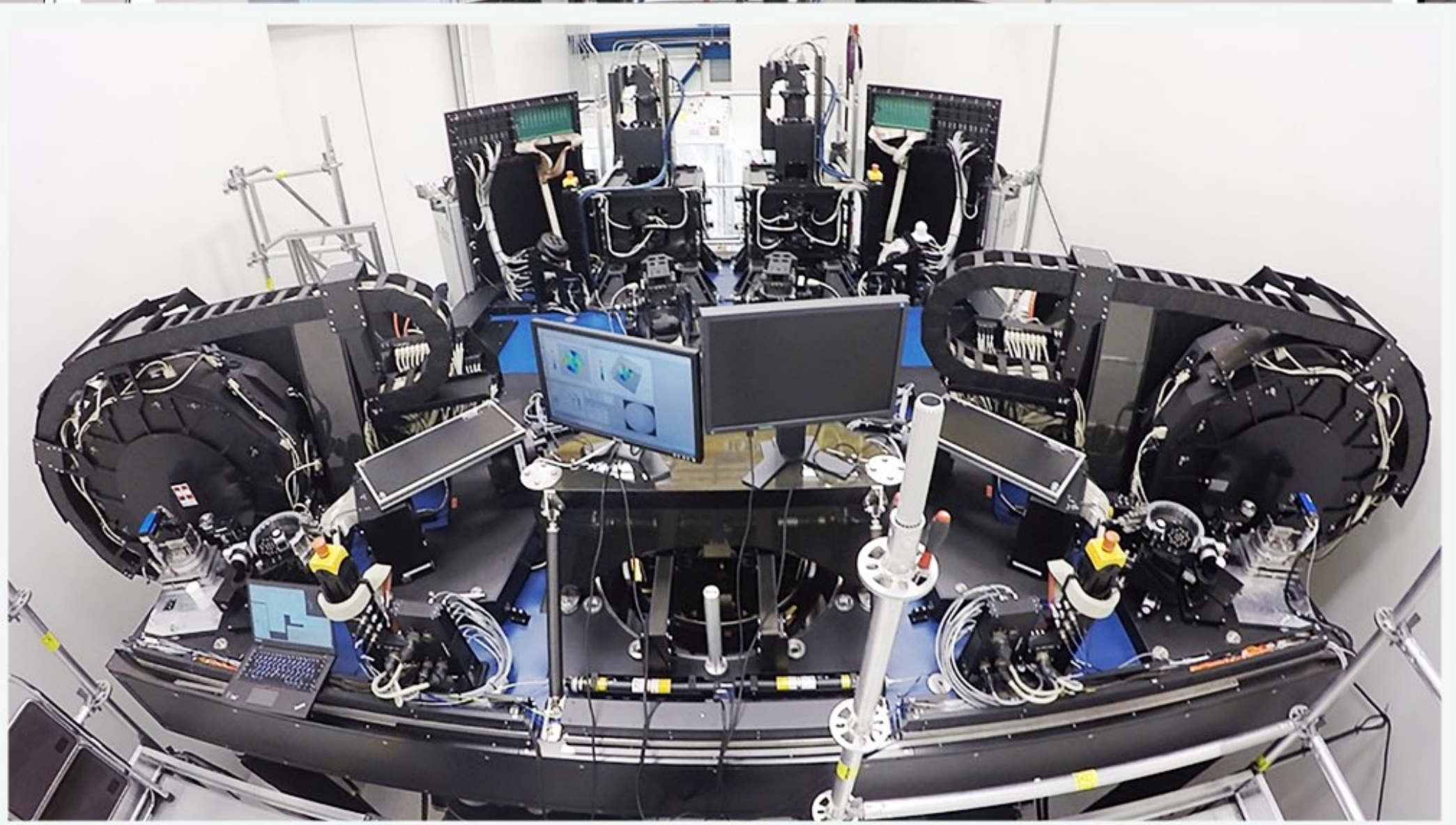

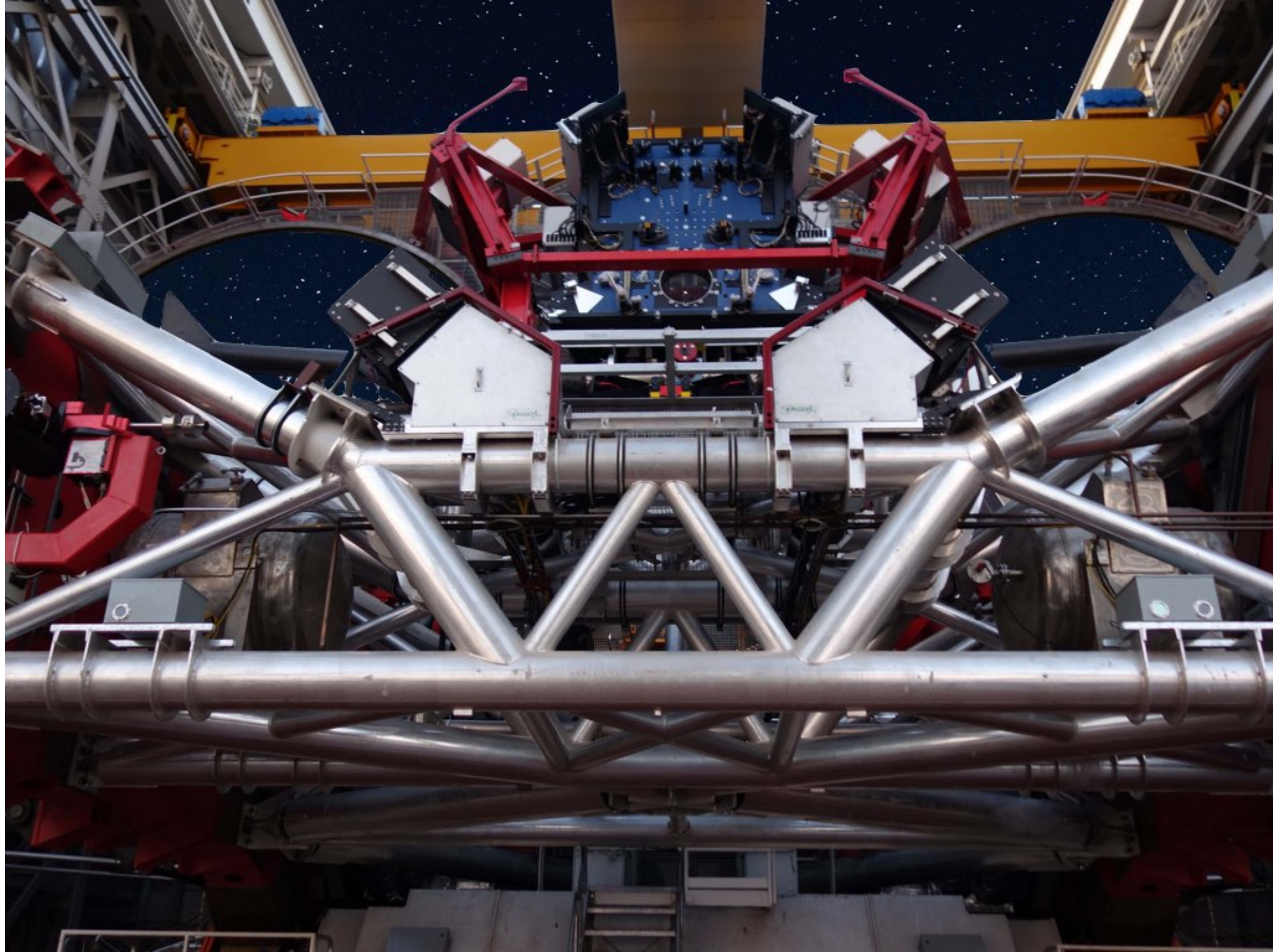



Wavefront







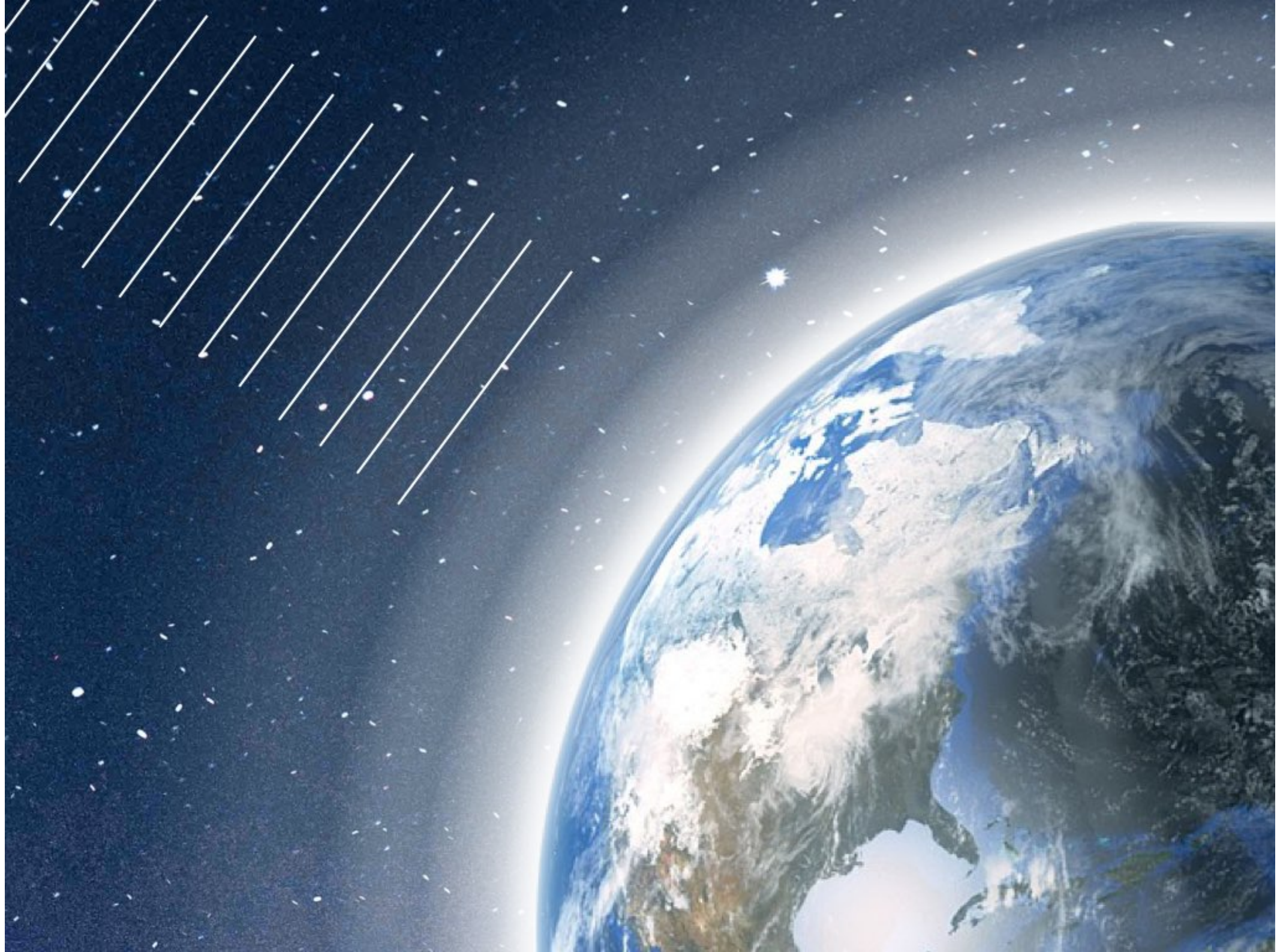

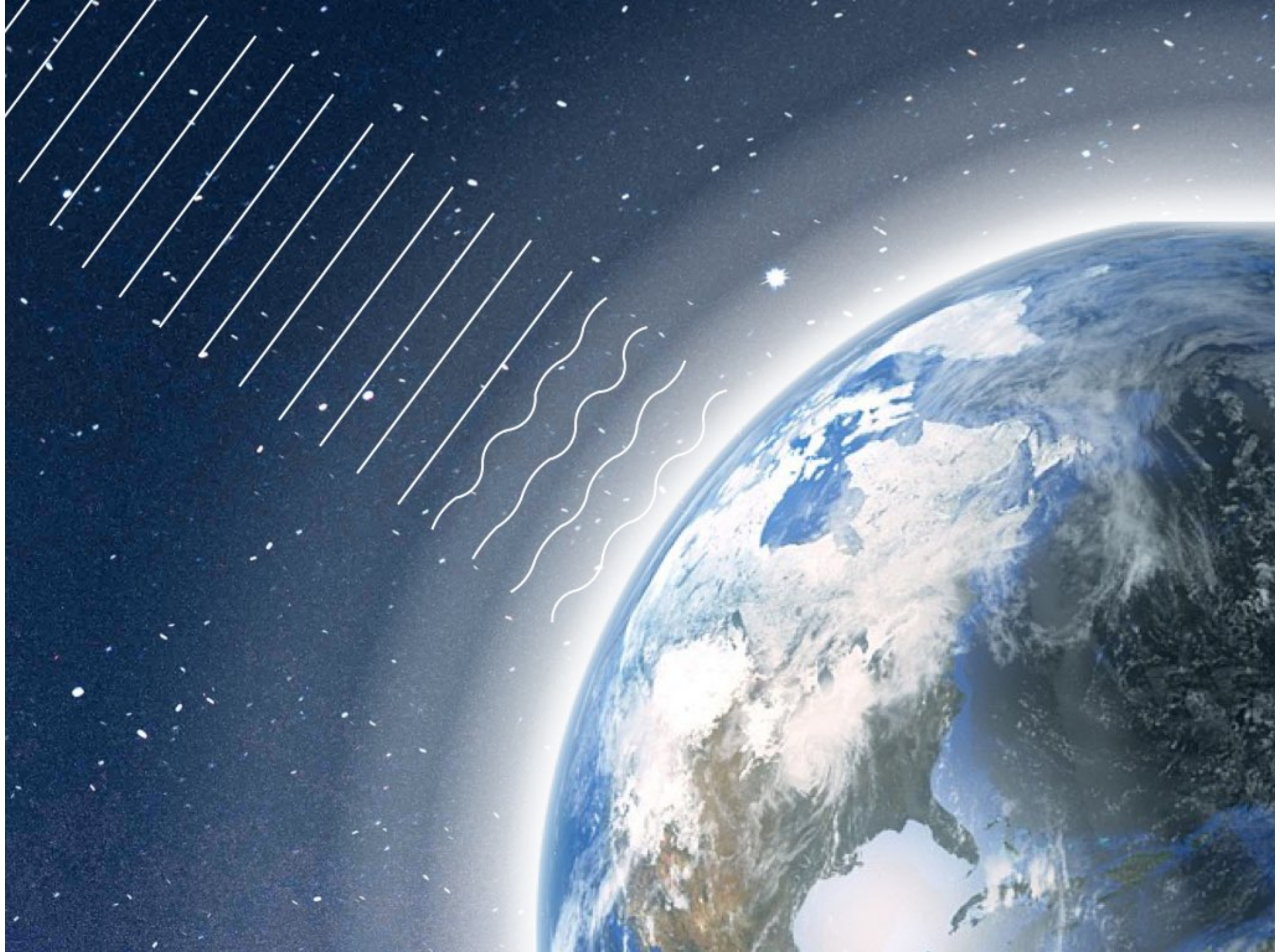





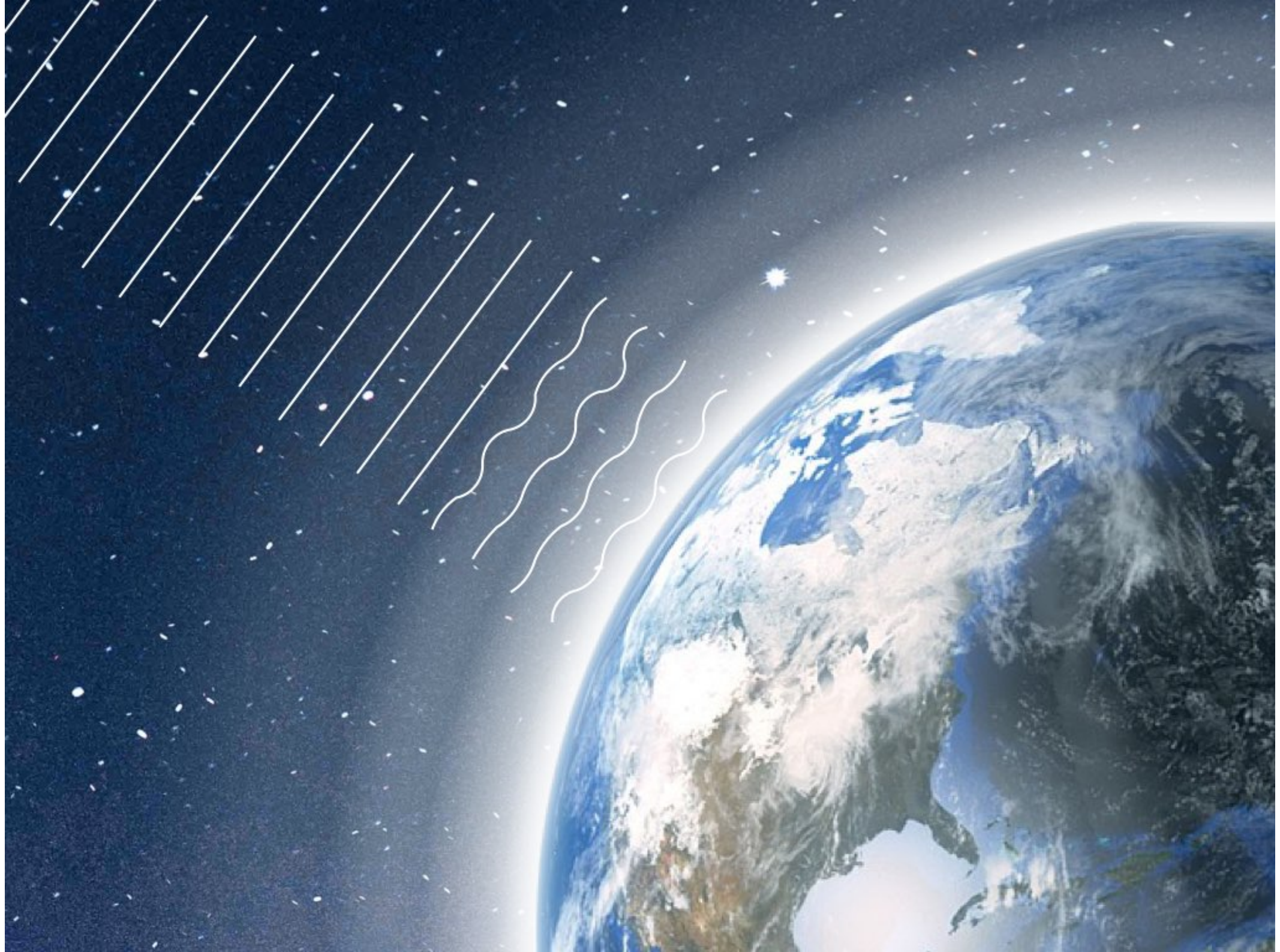

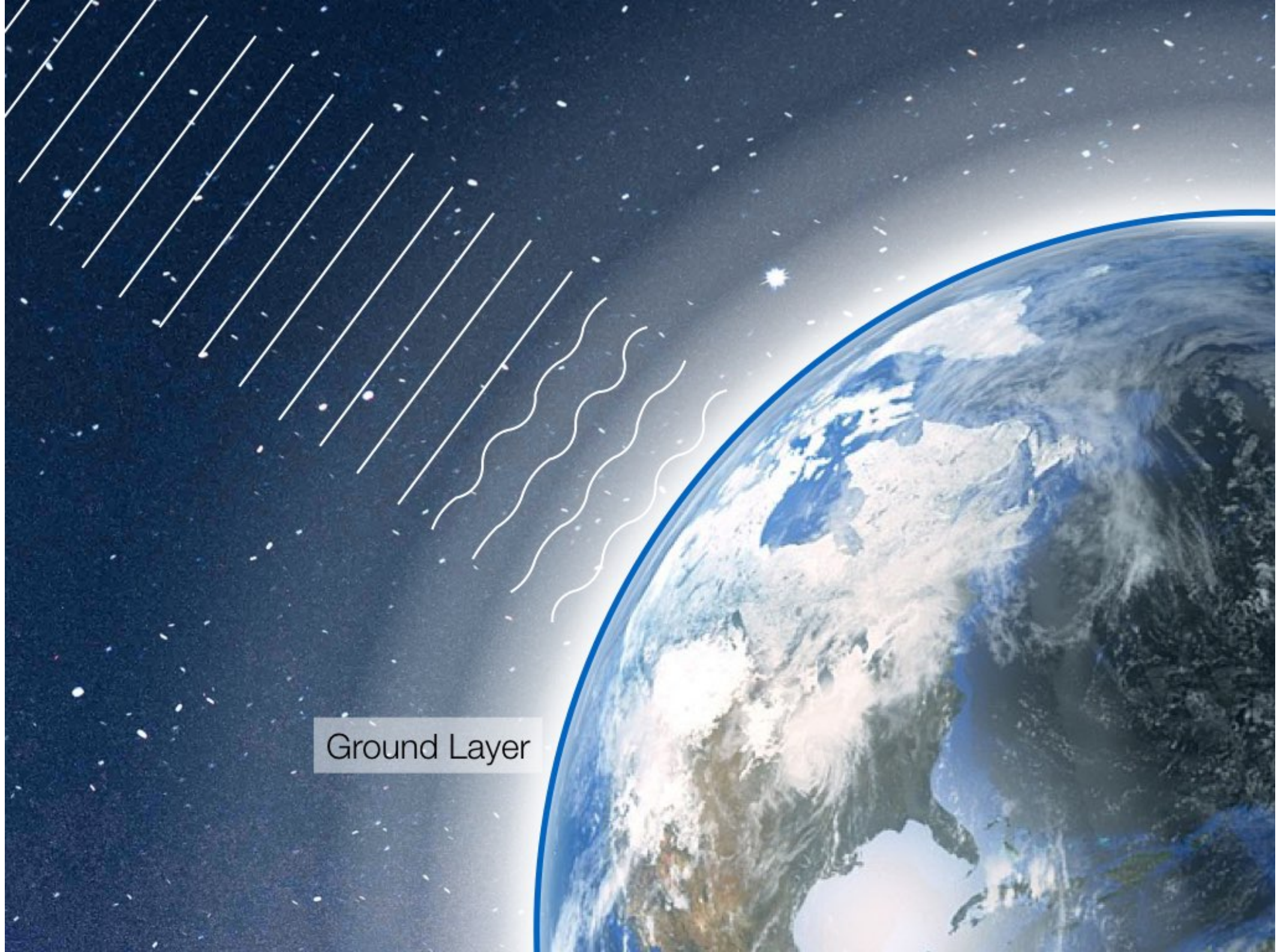

Ground Layer

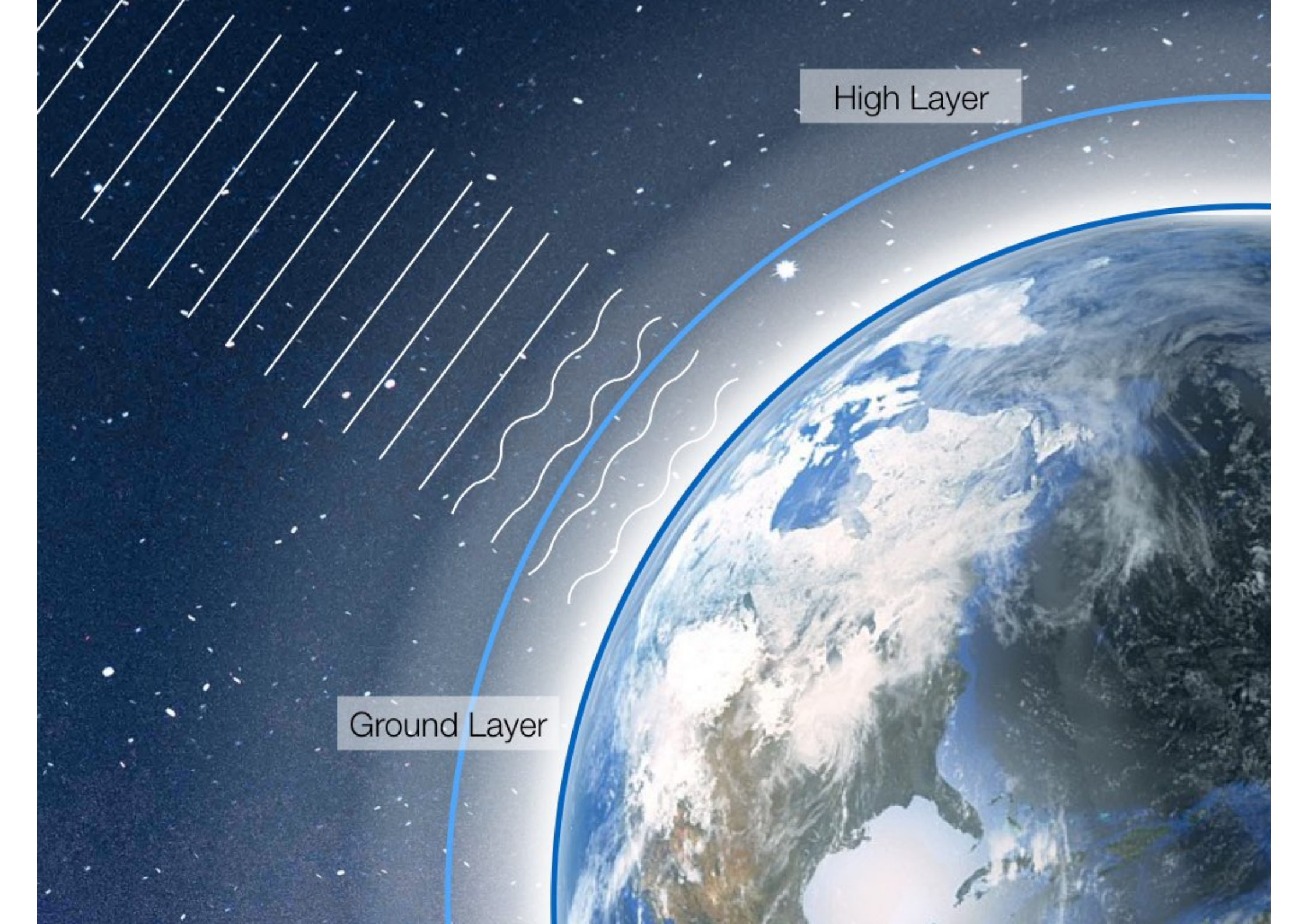
A diagram of Earth's atmosphere from space. The Earth's surface is on the right, showing continents and oceans. Two blue curved lines represent atmospheric boundaries. The region between the Earth's surface and the lower blue line is labeled 'Ground Layer'. The region between the two blue lines is labeled 'High Layer'. White wavy lines are shown between the layers, and white straight lines are shown above the 'High Layer'. The background is a dark blue space with white stars.

High Layer

Ground Layer



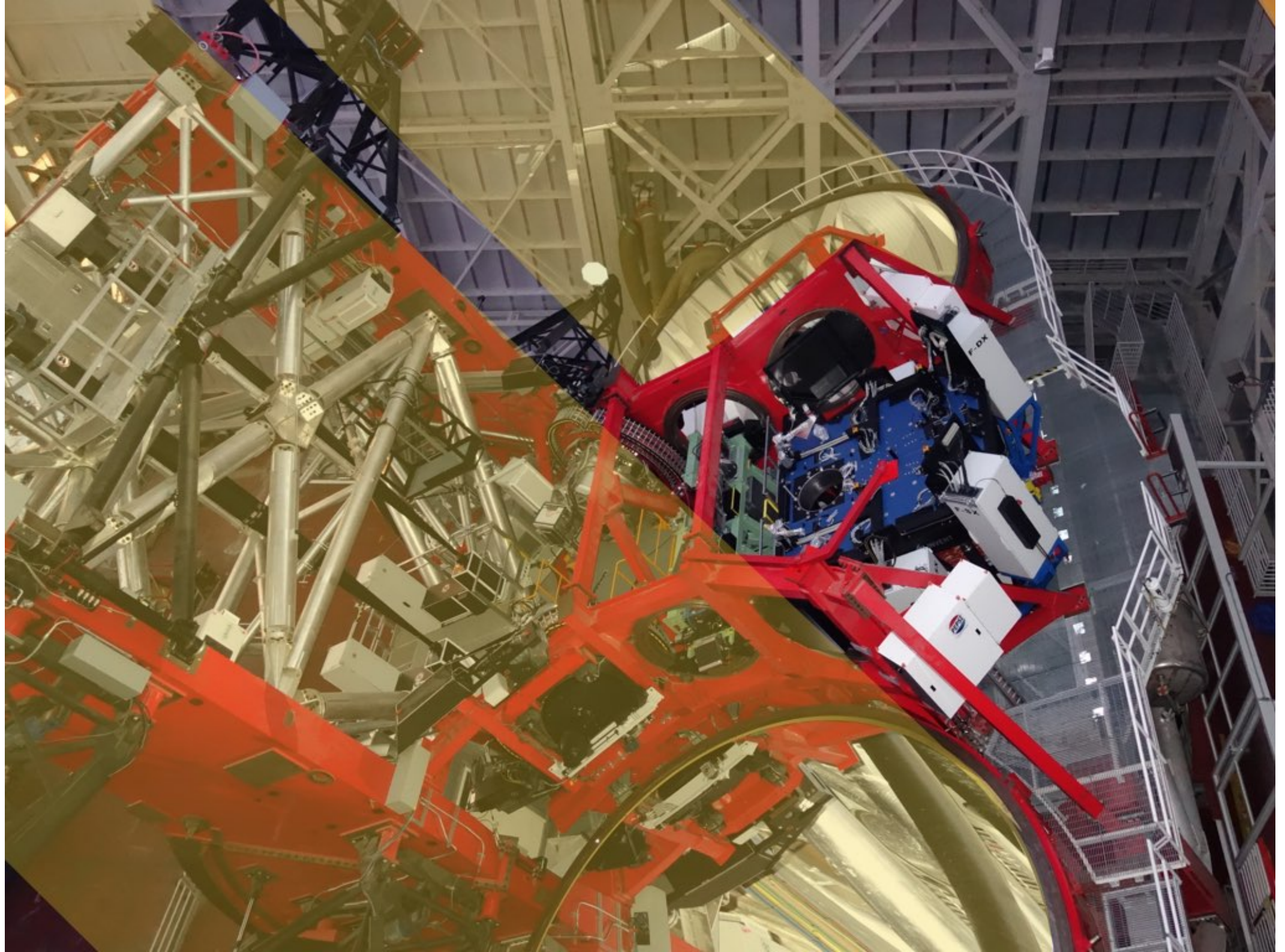





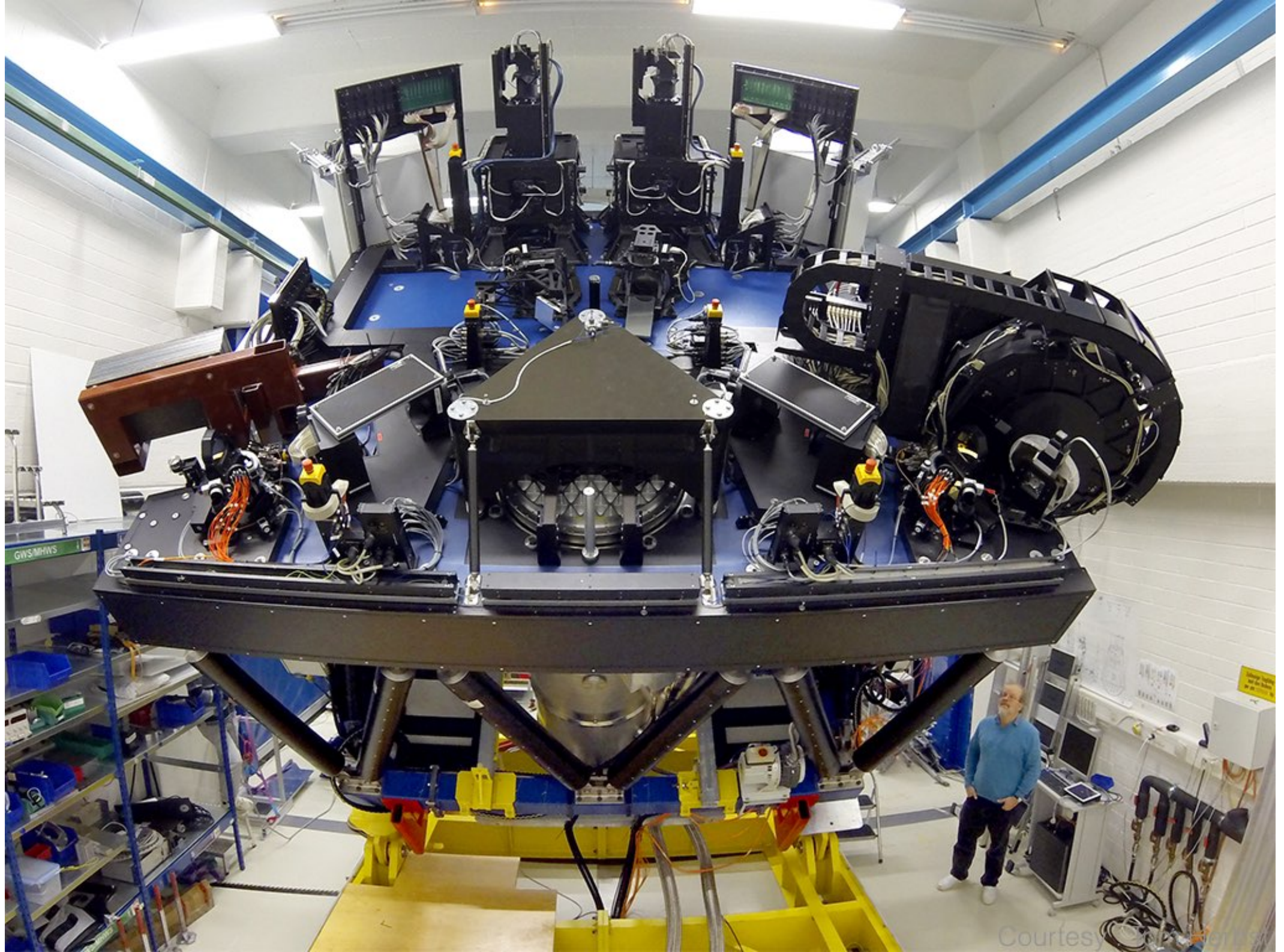

Courtesy



Courtesy : Tom Herbst

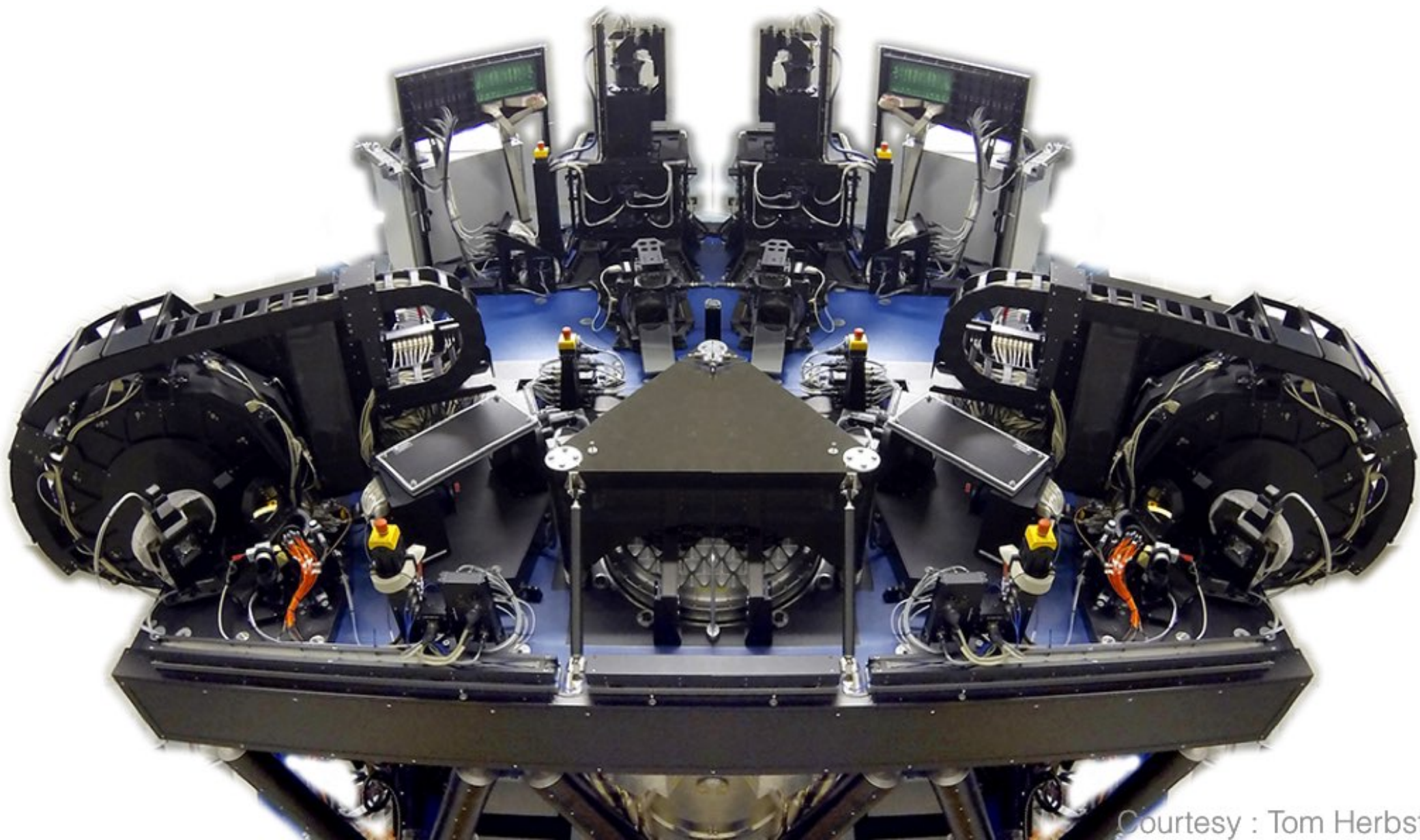

Courtesy : Tom Herbst

GWS: 12 NGS

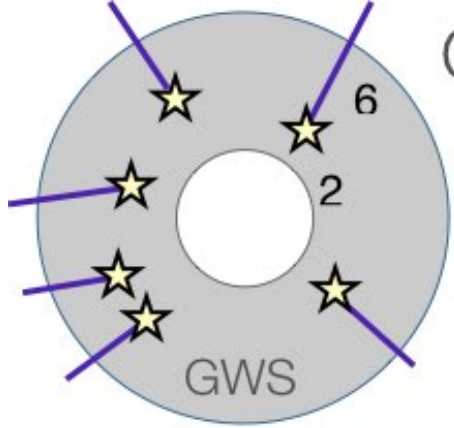

Ground-Layer
Sensor

Ground-Layer
Sensor

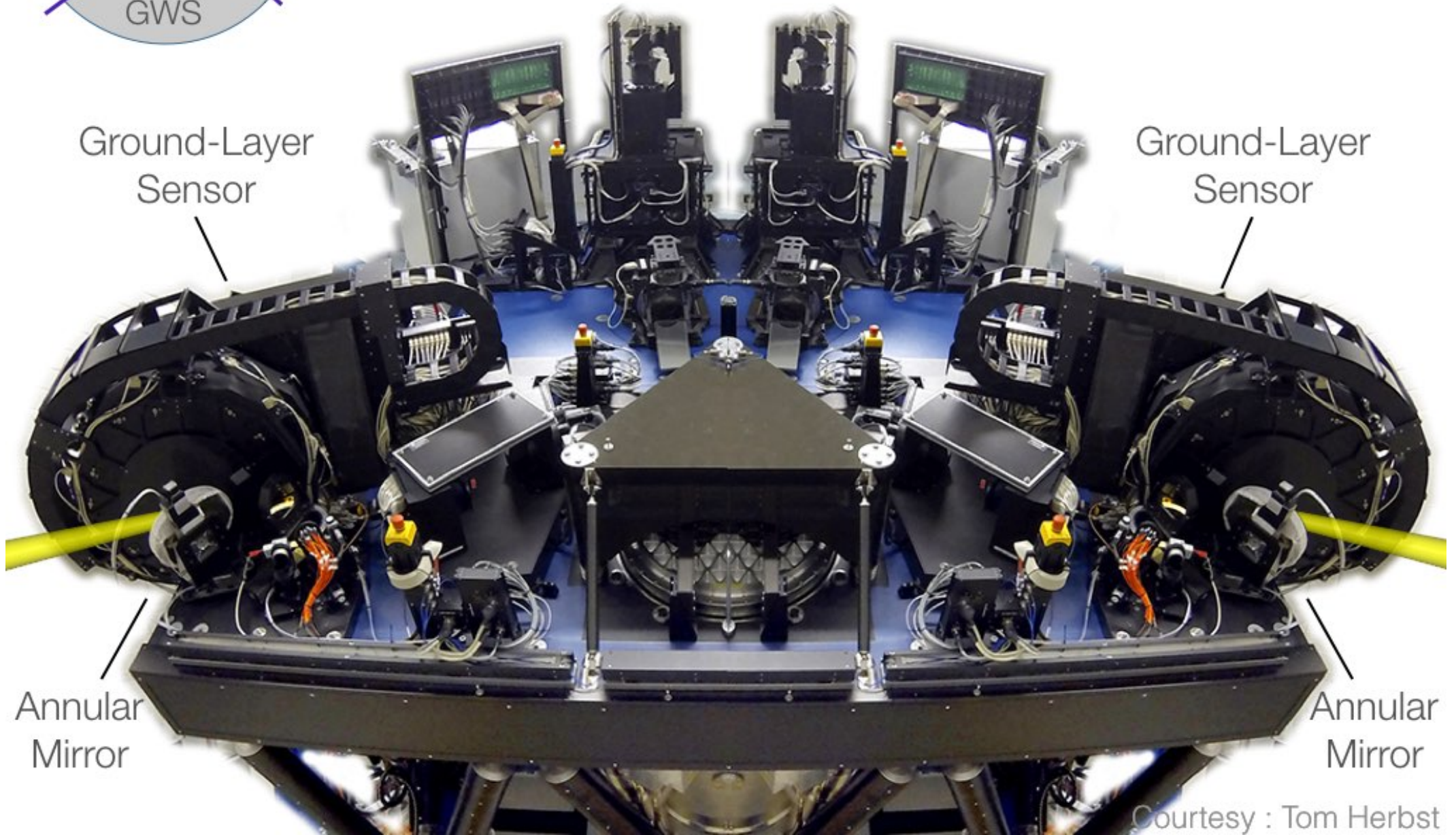

Annular
Mirror

Annular
Mirror

Courtesy : Tom Herbst

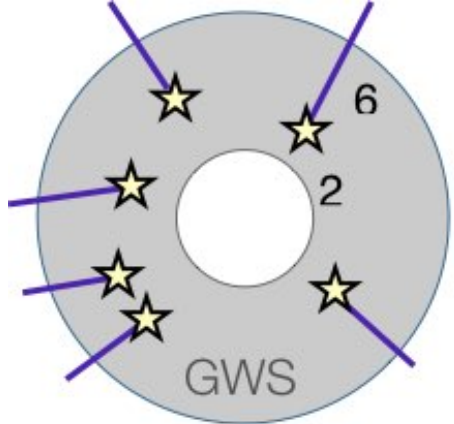

Xinetics
349 DM

Collimator

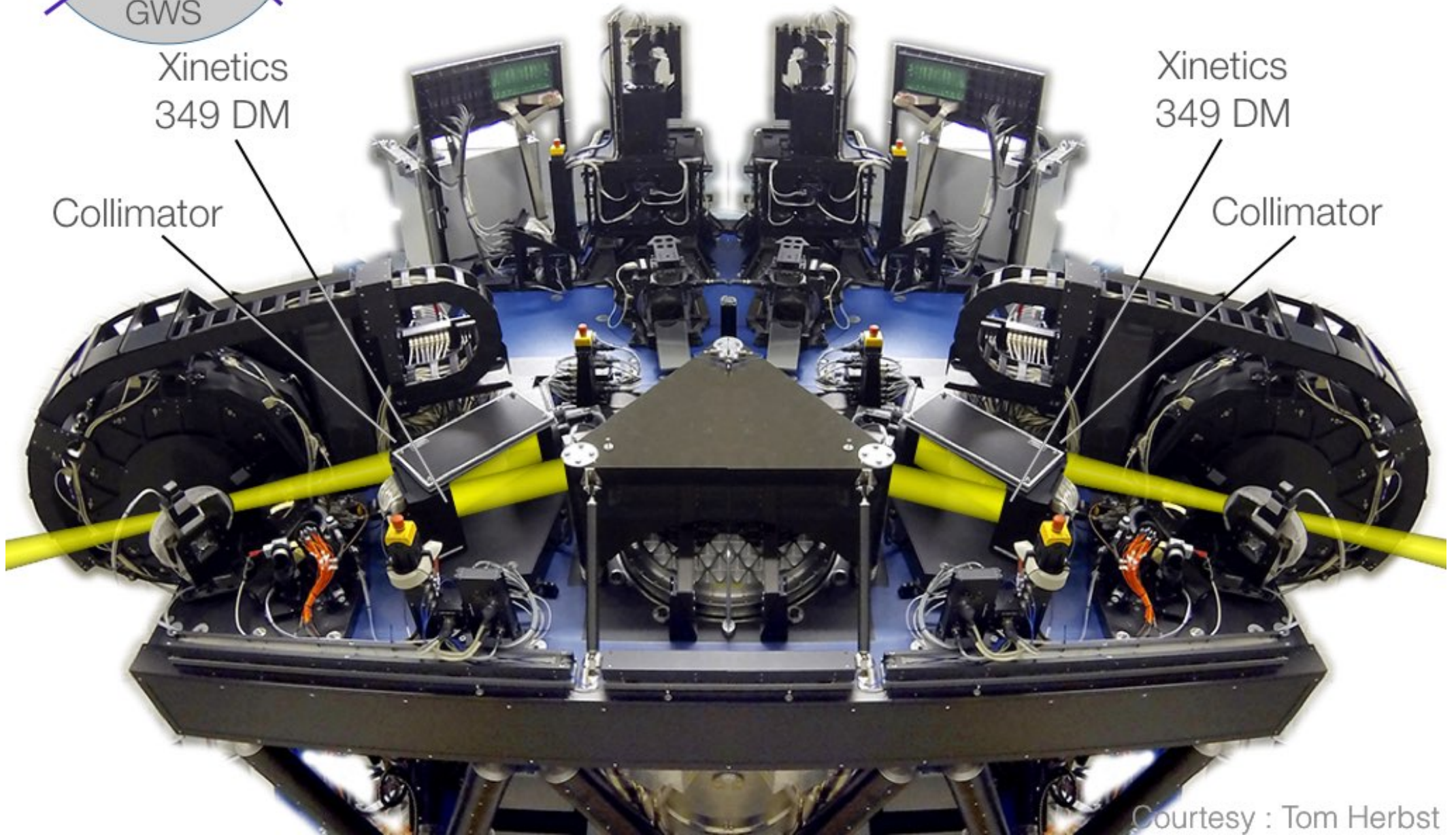

Xinetics
349 DM

Collimator

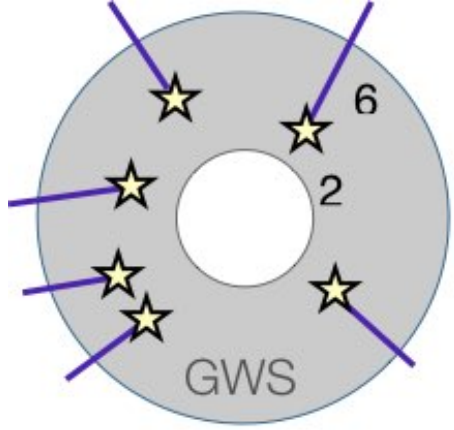

Vis-NIR Dichroic,
Beam Combiner

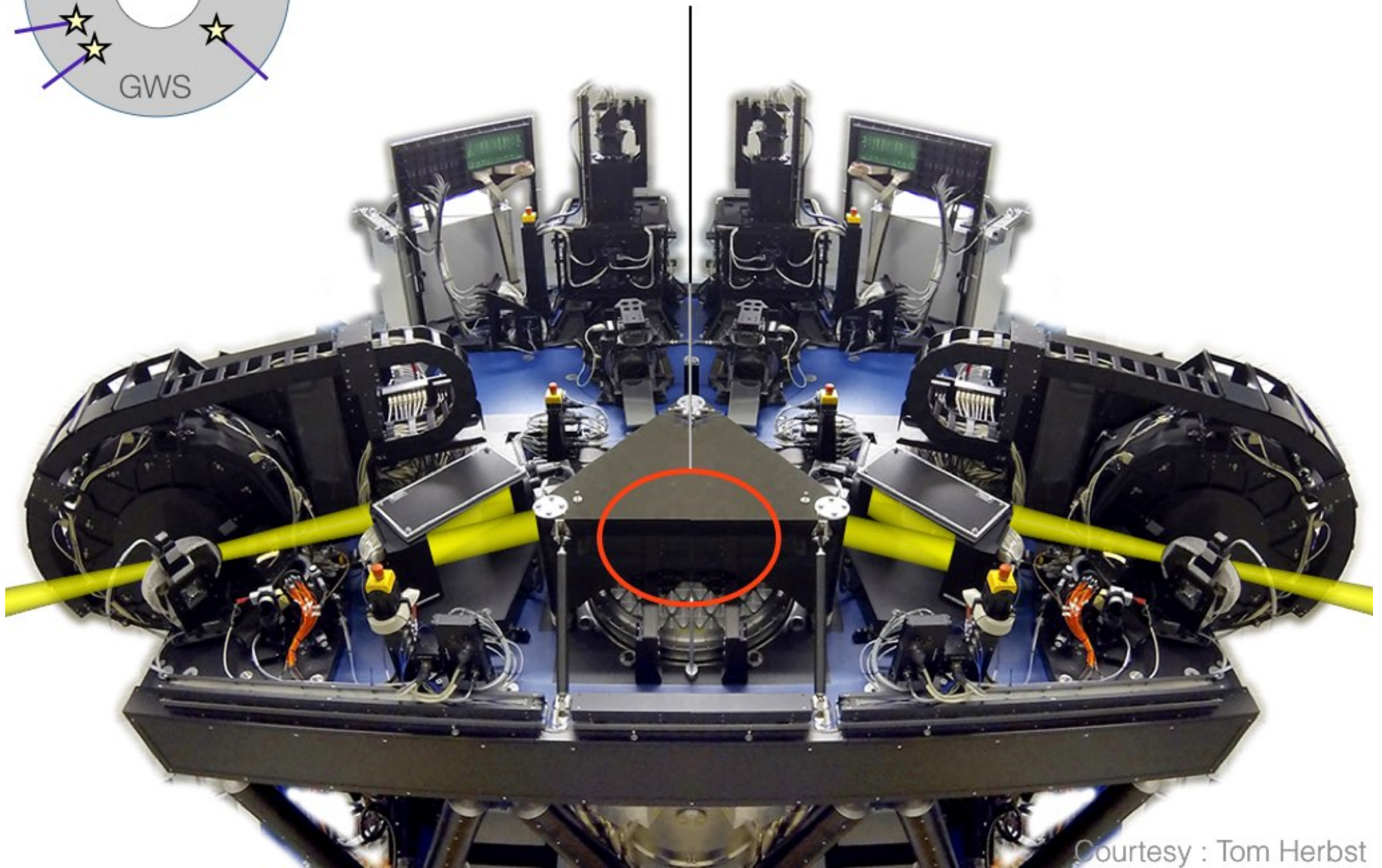

HWS: 8 NGS

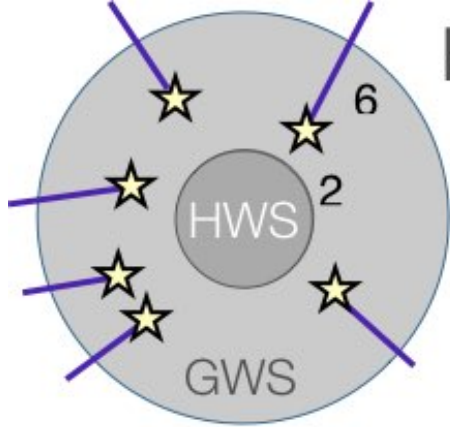

High-Layer Sensor

K-Mirror

K-Mirror

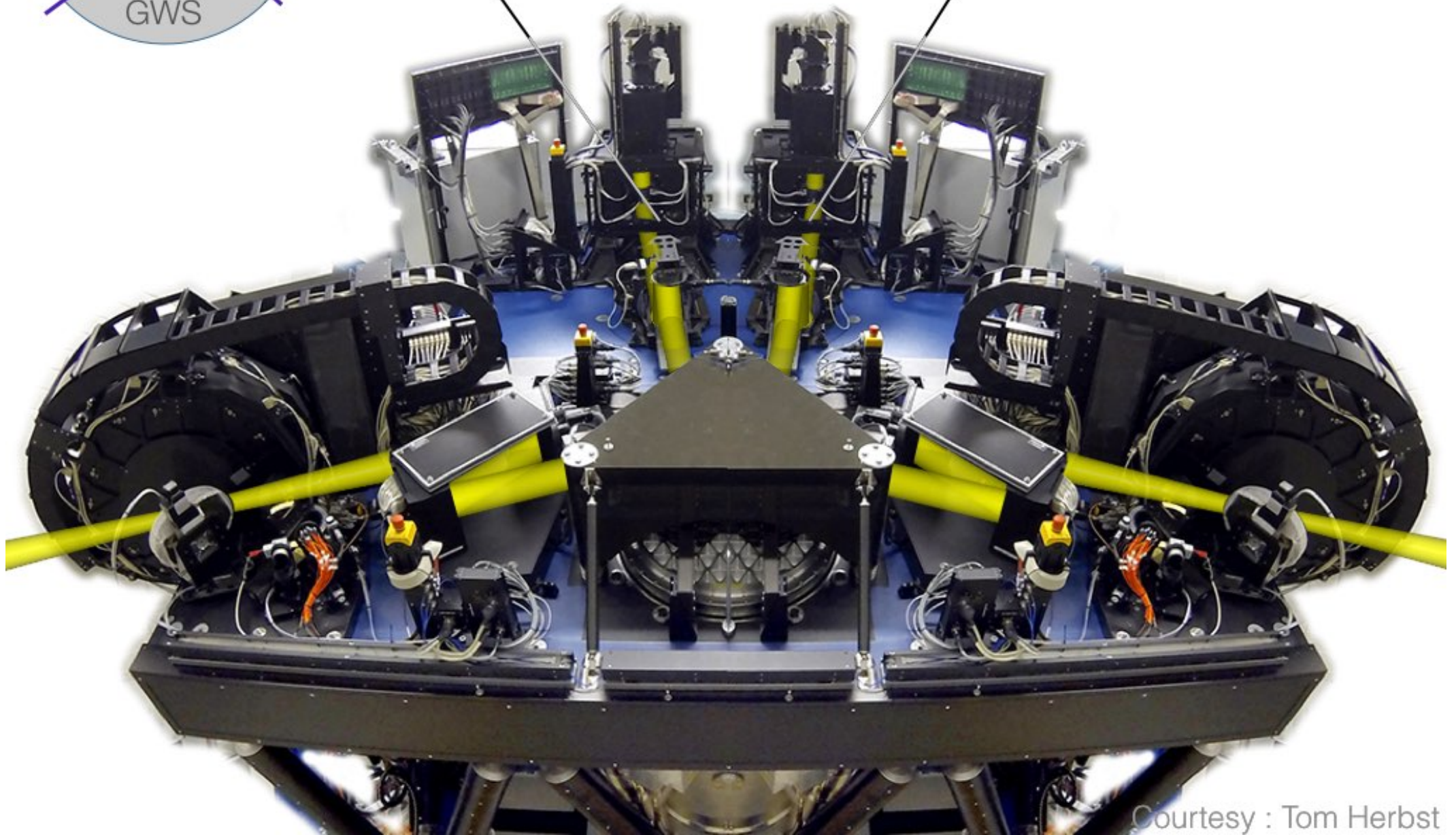

Courtesy : Tom Herbst

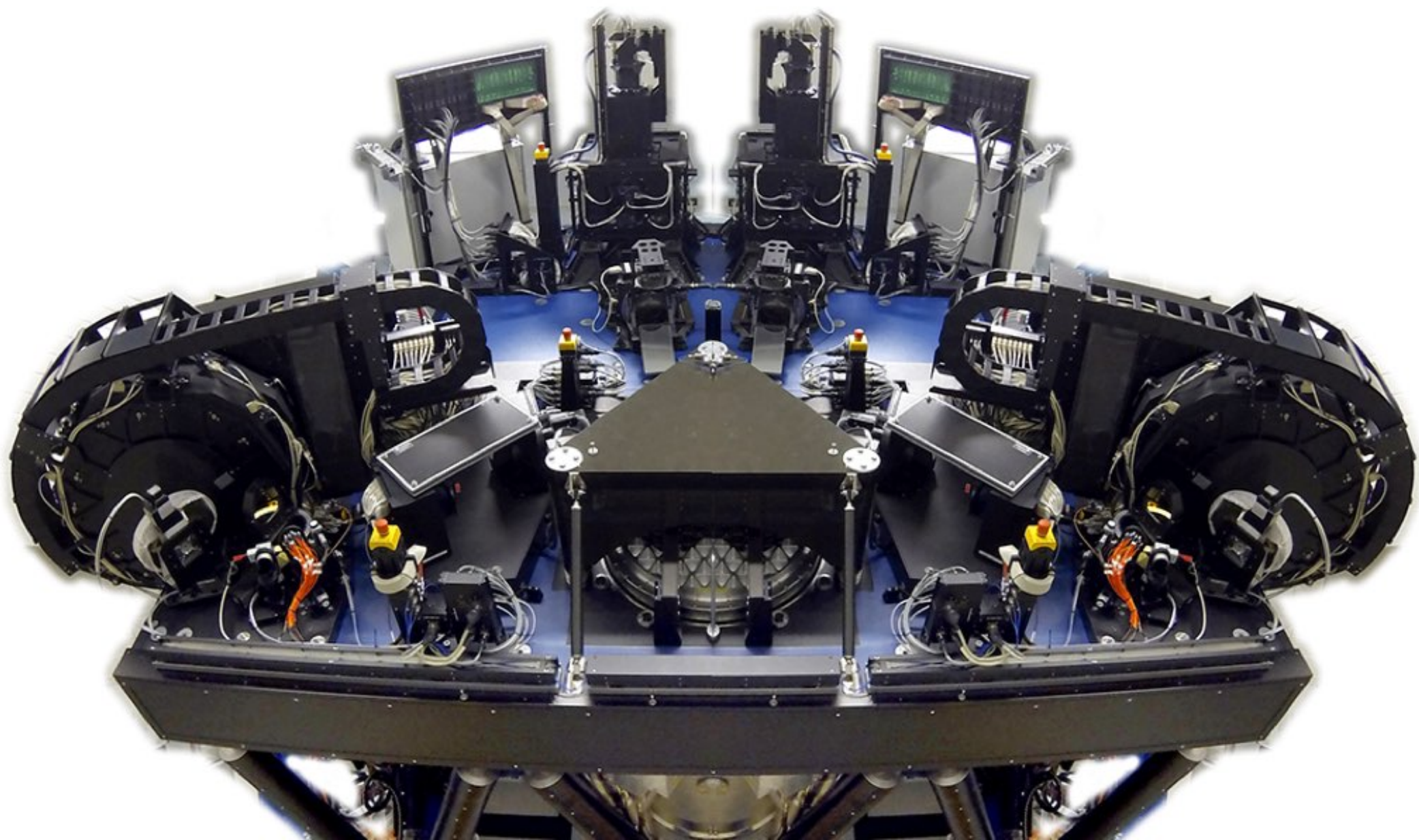

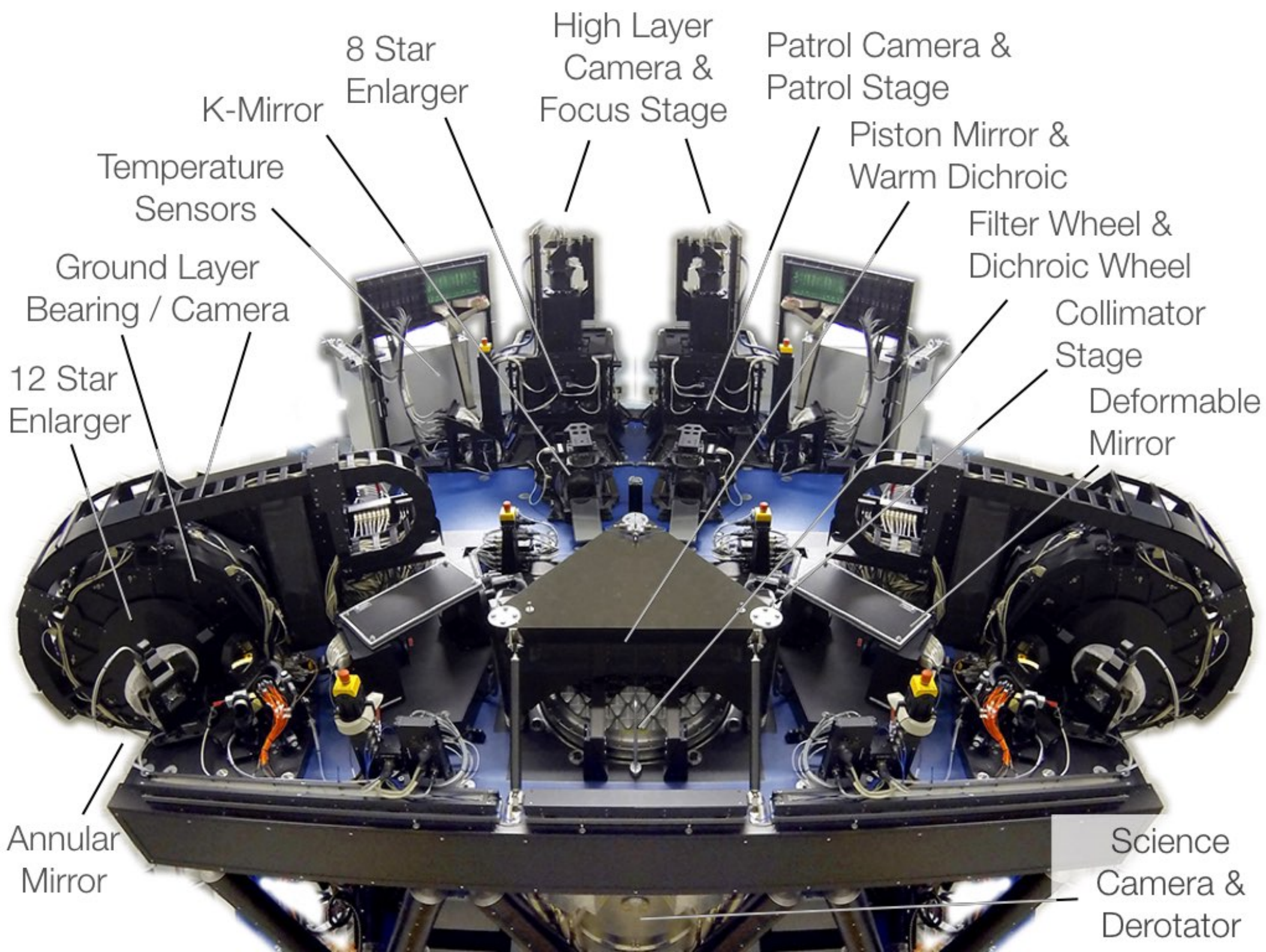

8 Star Enlarger

High Layer Camera & Focus Stage

Patrol Camera & Patrol Stage

K-Mirror

Piston Mirror & Warm Dichroic

Temperature Sensors

Filter Wheel & Dichroic Wheel

Ground Layer Bearing / Camera

Collimator Stage

12 Star Enlarger

Deformable Mirror

Annular Mirror

Science Camera & Derotator

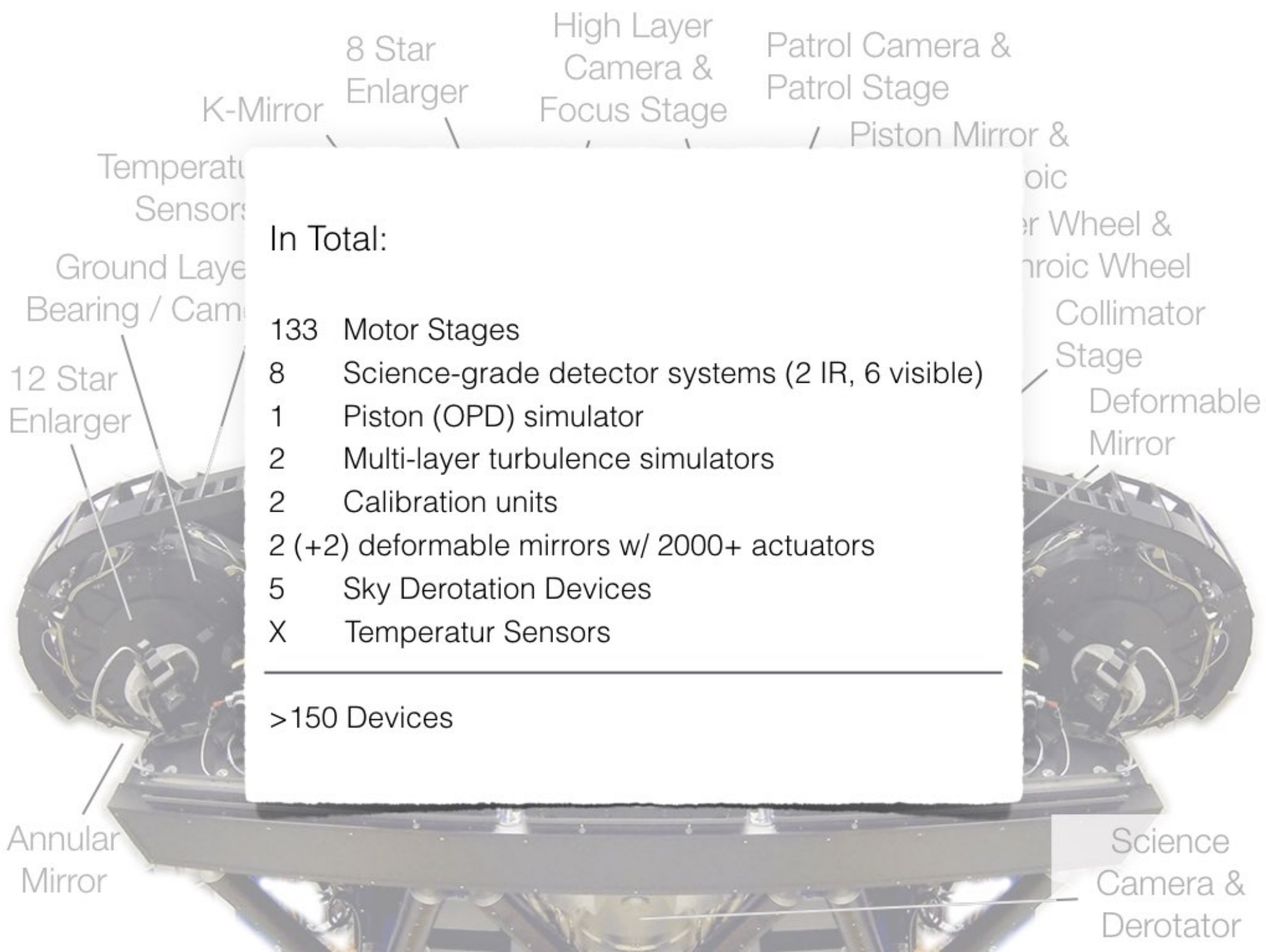

In Total:

- 133 Motor Stages
- 8 Science-grade detector systems (2 IR, 6 visible)
- 1 Piston (OPD) simulator
- 2 Multi-layer turbulence simulators
- 2 Calibration units
- 2 (+2) deformable mirrors w/ 2000+ actuators
- 5 Sky Derotation Devices
- X Temperature Sensors

>150 Devices



A person wearing a grey hoodie is centered in the frame, facing forward. The background is a light blue color with a pattern of white binary code (0s and 1s) scattered throughout. The text 'What is a Software Developer?' is overlaid on the person's chest area.

What is a Software Developer?

What is a Software Developer?

```
def main():  
    print "Hello World!"  
  
if __name__ == "__main__":  
    main()
```

```
> Hello World!
```



A person wearing a grey hoodie is centered in the frame, their face obscured by a dark circular shadow. The background is a light blue gradient with horizontal lines of binary code (0s and 1s) in a lighter blue color. Some binary digits are highlighted in red. The overall aesthetic is digital and tech-oriented.

What is a Software Developer?

A person wearing a grey hoodie is centered in the frame, facing forward. The background is a light blue color with a pattern of white binary code (0s and 1s) scattered throughout. The text is overlaid on the person's chest area.

What is a Software Developer?

Software Architect

A person wearing a grey hoodie is centered in the image, their face obscured by a dark grey circle. The background is a light blue gradient with horizontal lines of binary code (0s and 1s) in a lighter blue color. Some binary digits are highlighted in red. The overall aesthetic is digital and tech-oriented.

What is a Software Developer?

Software Architect
Coder

A person wearing a grey hoodie is centered in the image, facing forward. The background is a light blue gradient with horizontal lines of binary code (0s and 1s) in a lighter blue color. Some binary digits are highlighted in red. The overall aesthetic is digital and tech-oriented.

What is a Software Developer?

Software Architect
Coder
Tester



Software Architect

Software Architect



1	710 x 1510	1	1000 x 1000
2	1710 x 1510	2	1000 x 1000
3	2510 x 1510	3	1000 x 1000
4	1710 x 2410	4	1000 x 1000

1	710 x 1510	1	1000 x 1000
2	1710 x 1510	2	1000 x 1000
3	2510 x 1510	3	1000 x 1000
4	1710 x 2410	4	1000 x 1000

1	710 x 1510	1	1000 x 1000
2	1710 x 1510	2	1000 x 1000
3	2510 x 1510	3	1000 x 1000
4	1710 x 2410	4	1000 x 1000

Software Architect

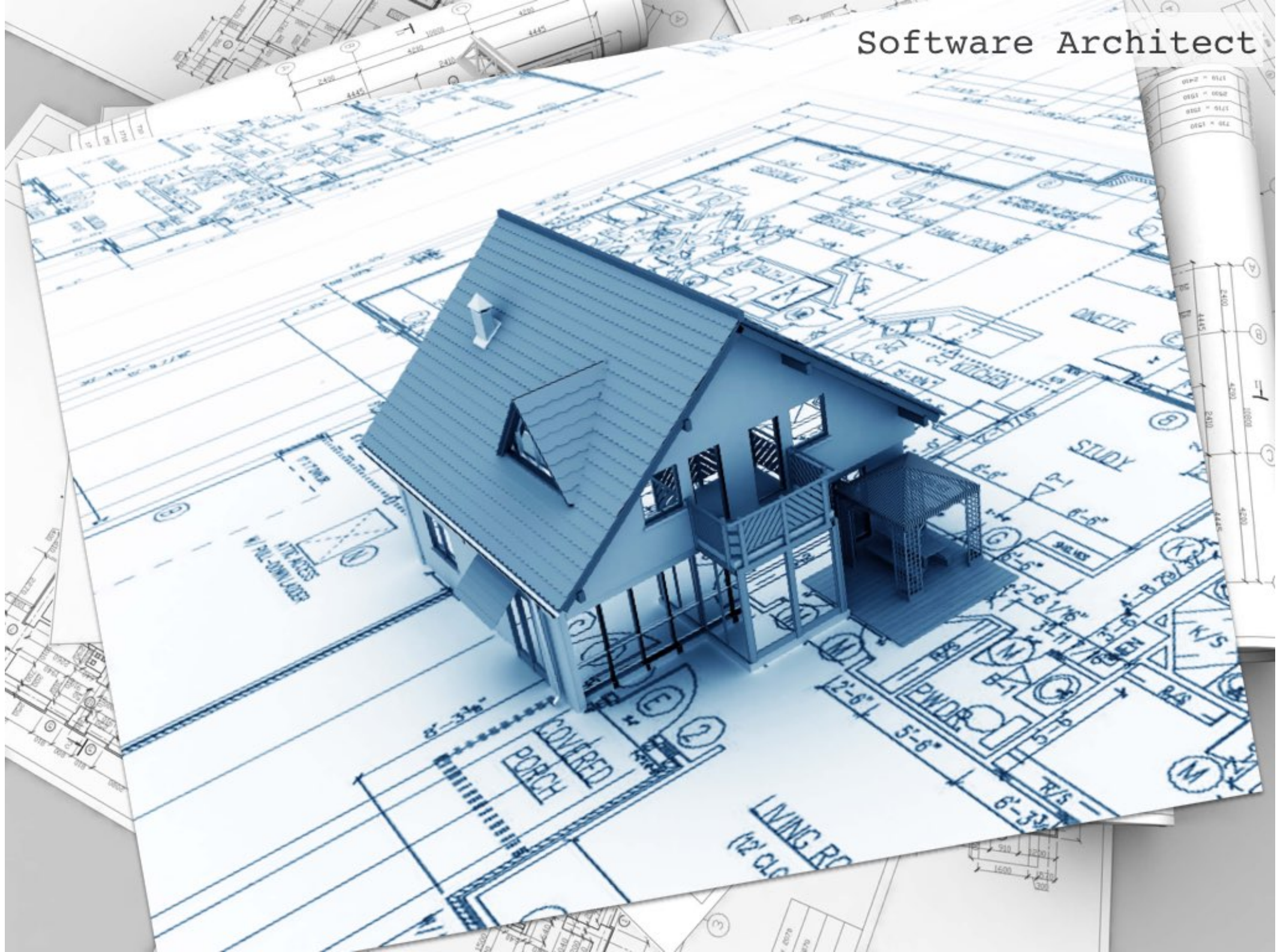

Software Architect

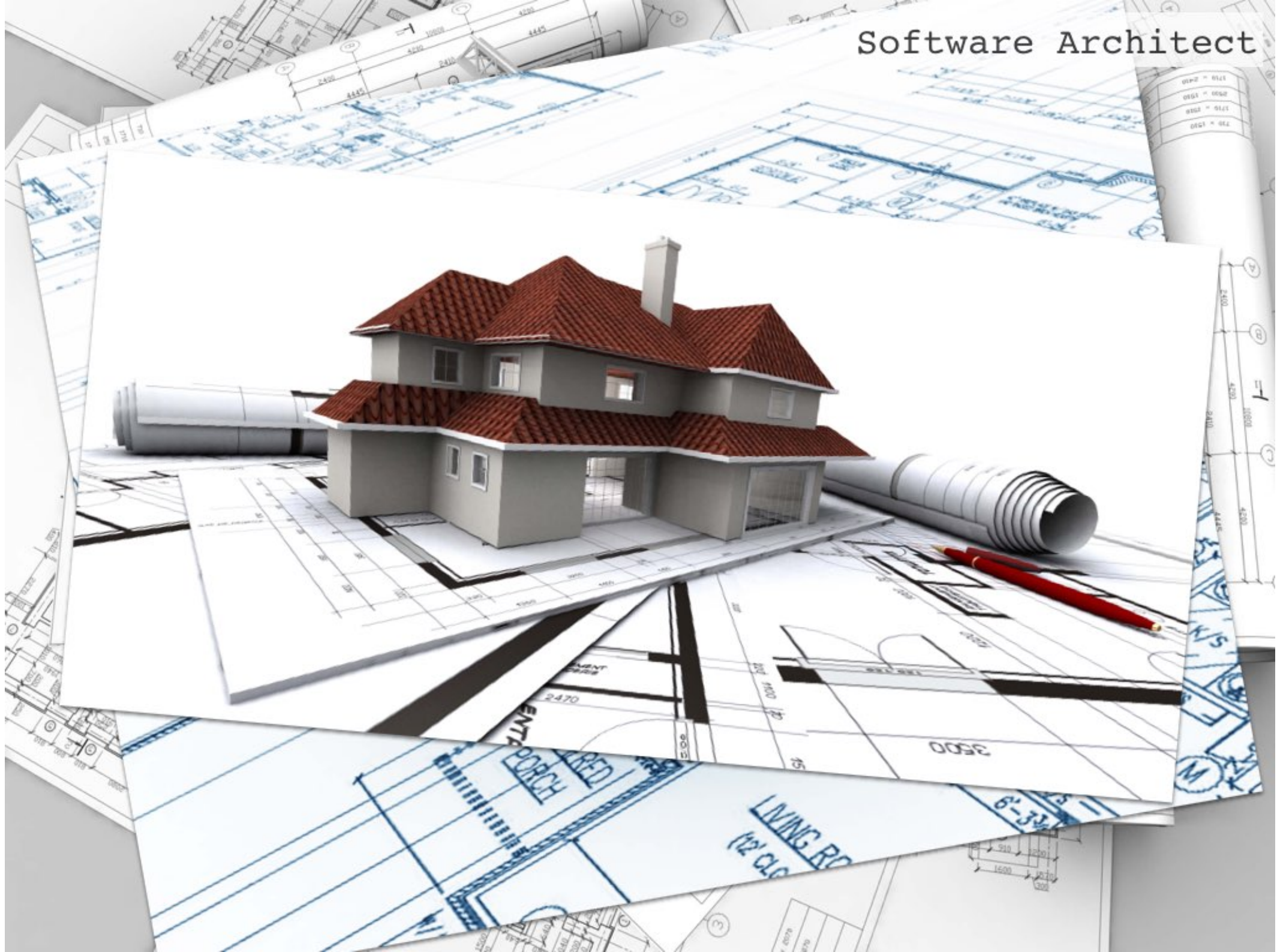



Coder

400.000



1.355.473

The image features a complex digital environment with several overlapping windows and floating text elements. The windows contain various code snippets, including assembly-like instructions such as `MOV AX, @data`, `PUSH AX`, `INT 21H`, and `POP AX`. There are also data structures like `MODEL SMALL`, `STACK 100h`, and `DATABASE`. The overall aesthetic is a futuristic, data-driven digital space with a green color palette.



Tester

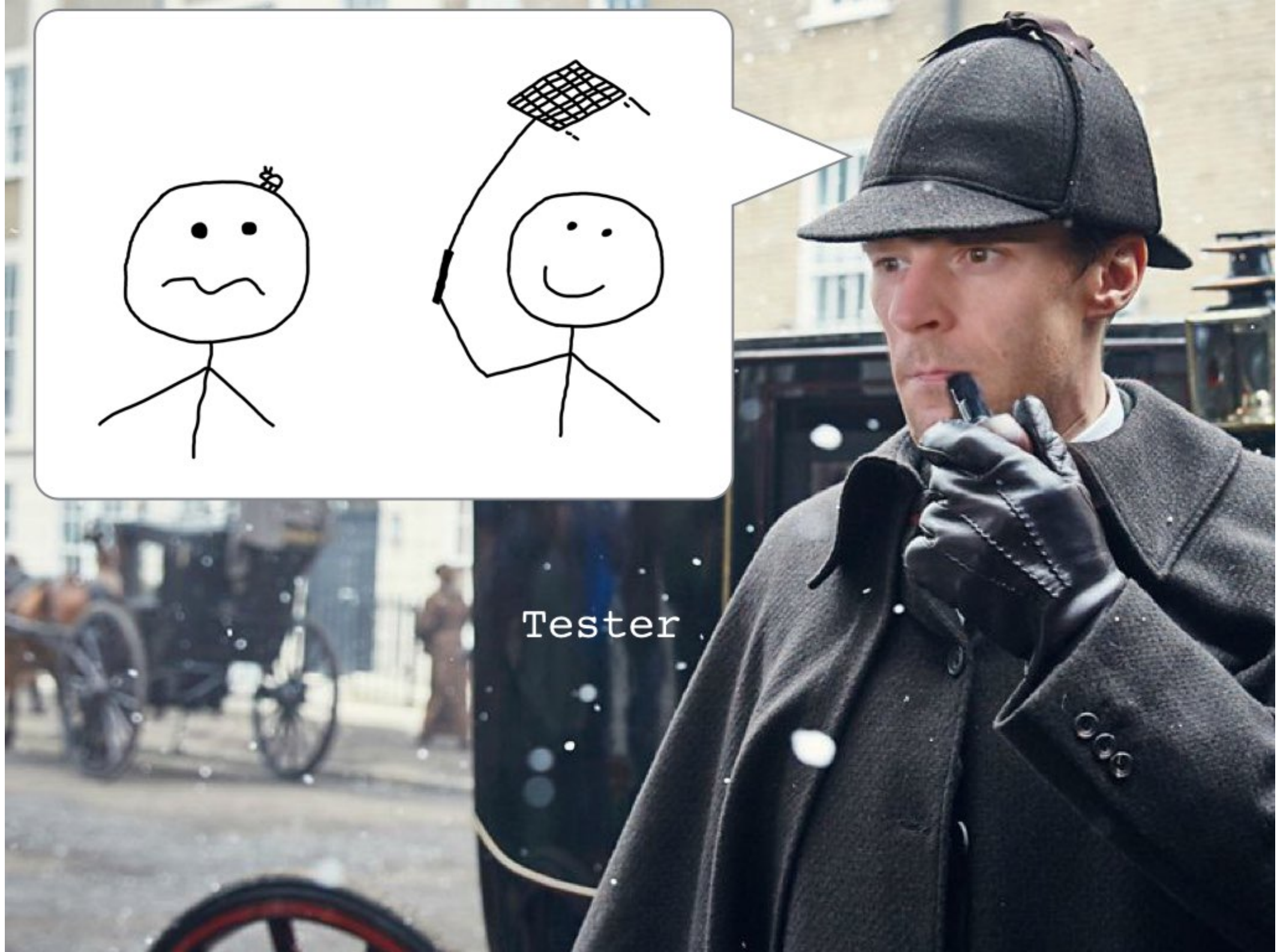
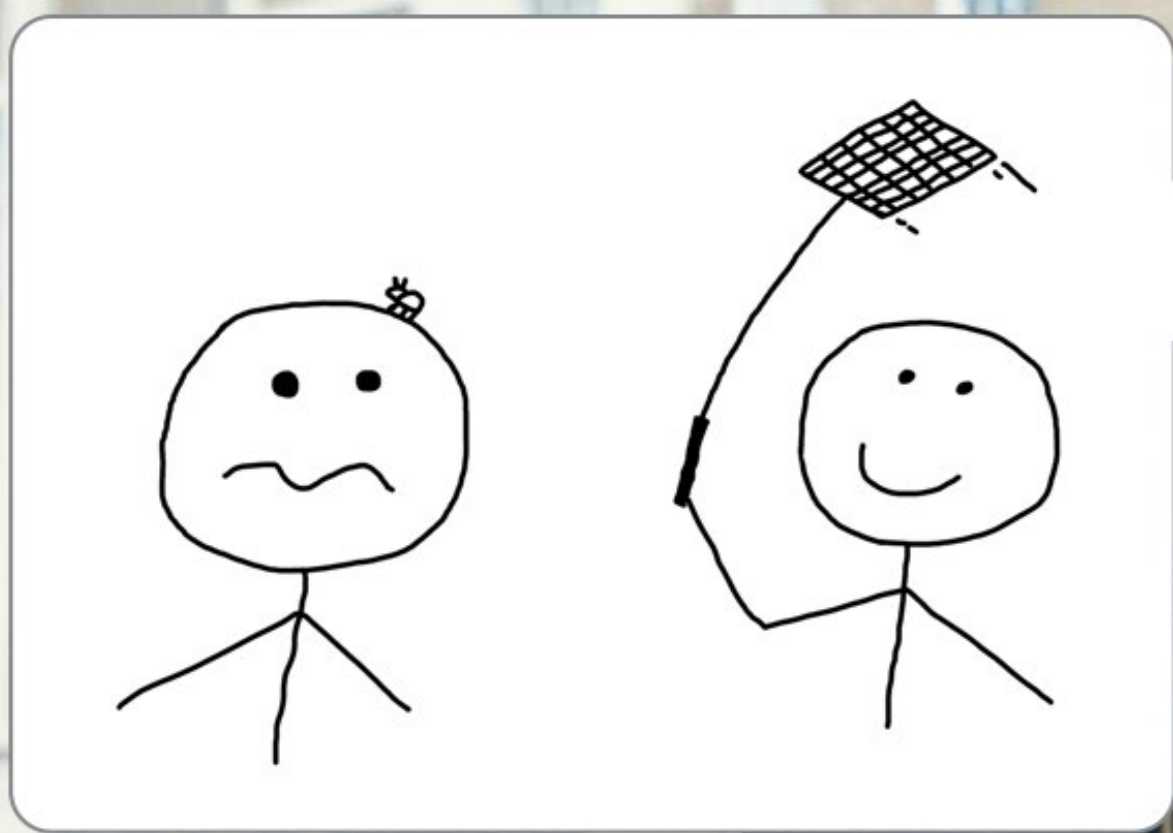

Tester







Software Developer



What does that mean for Linc Nirvana?

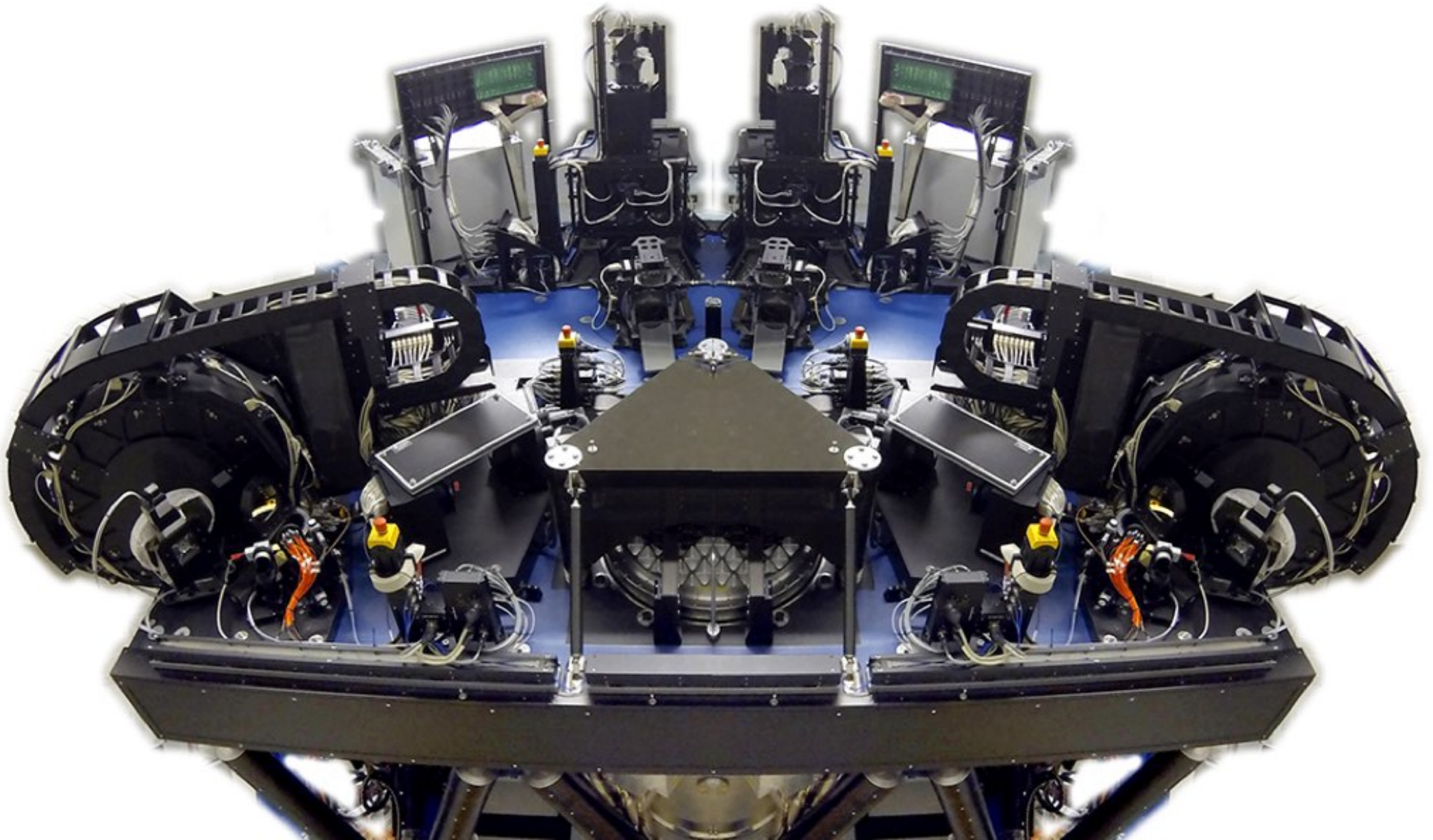

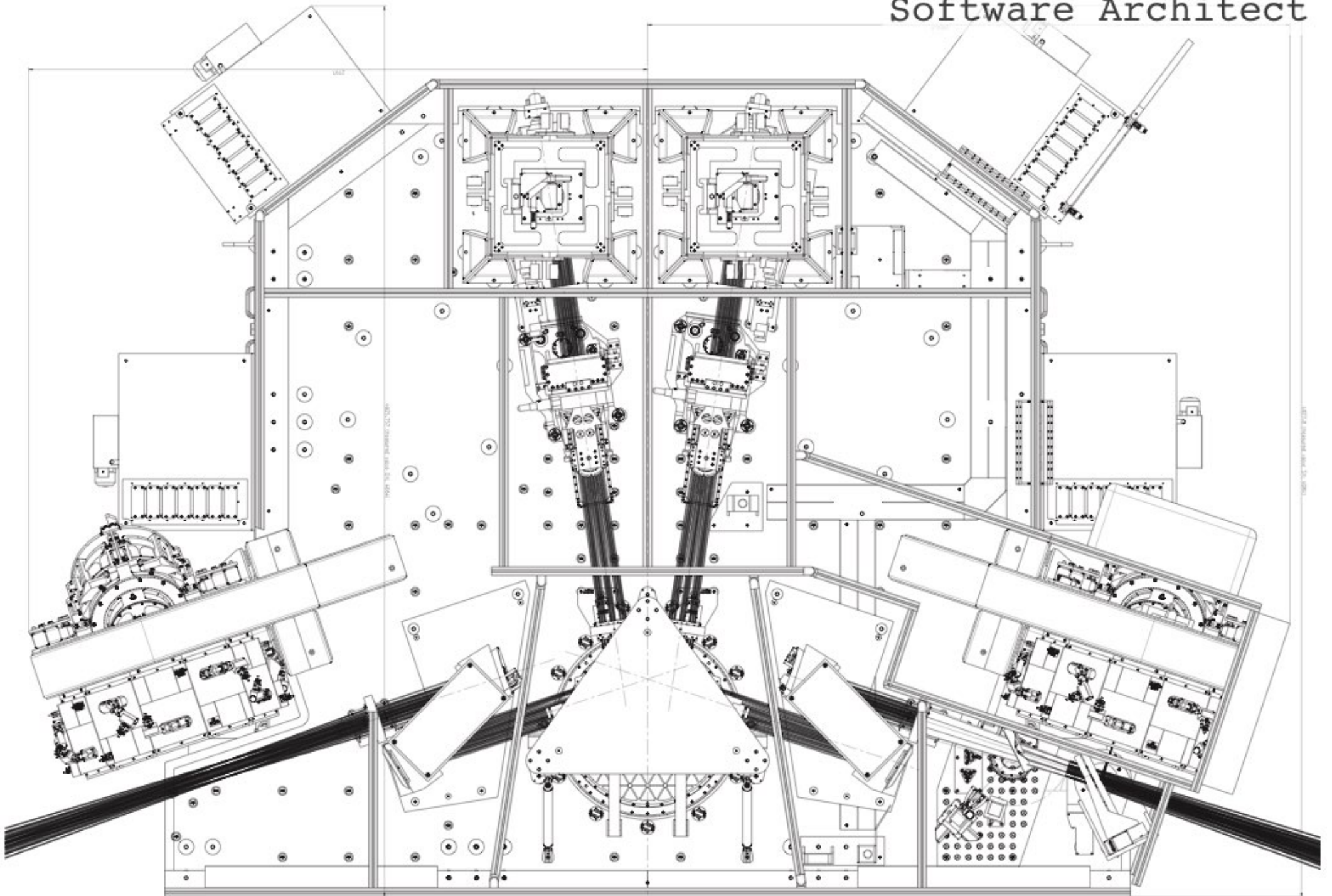









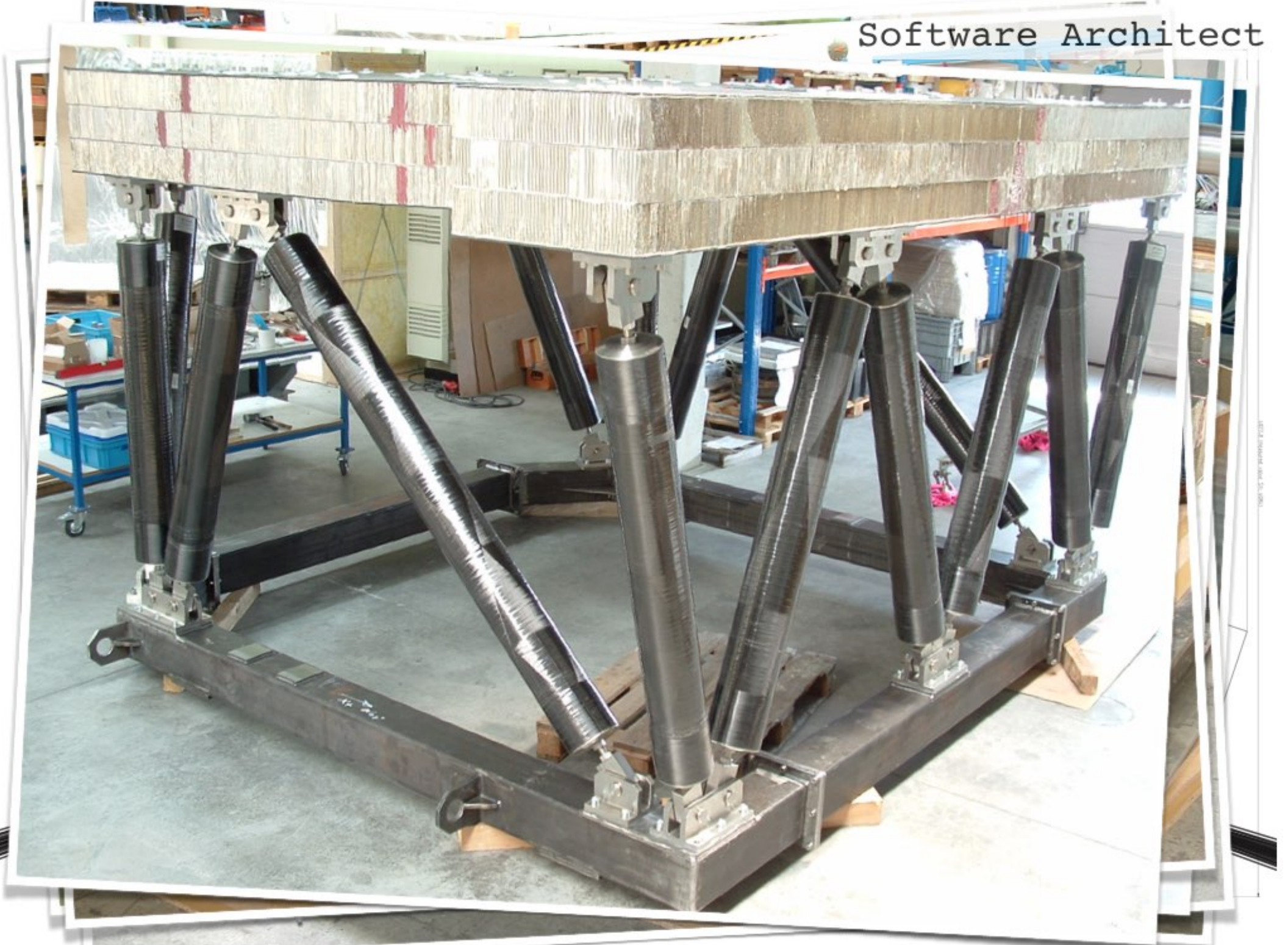

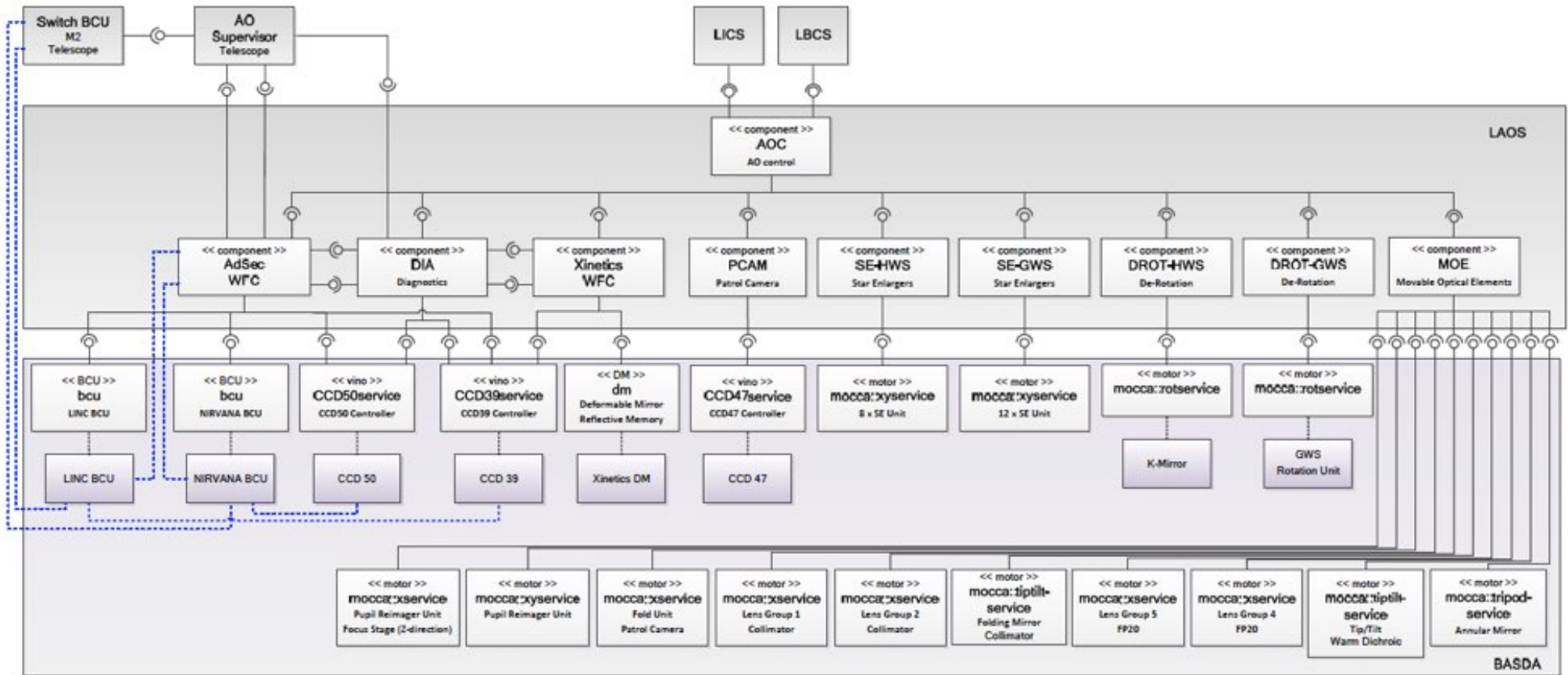

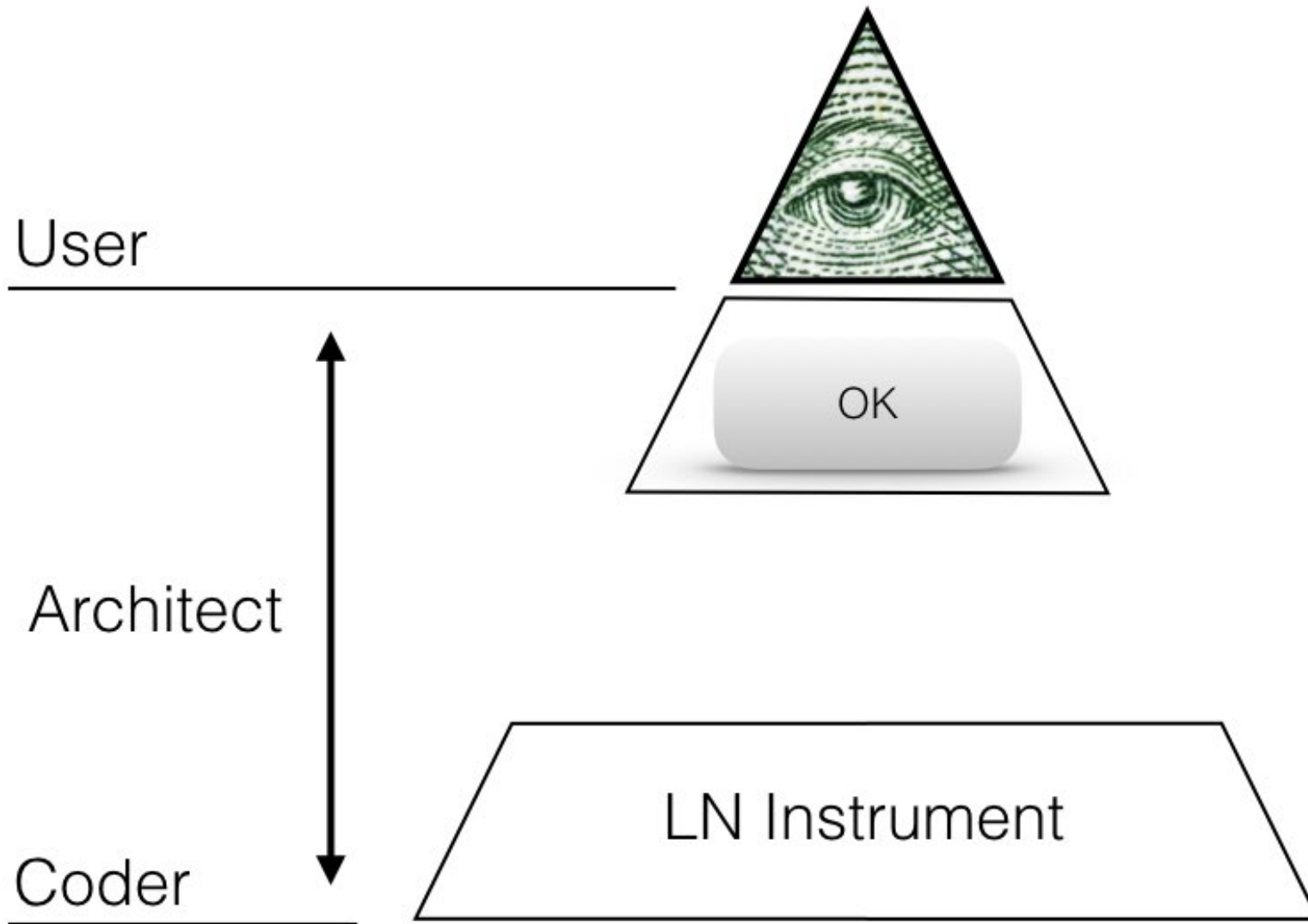

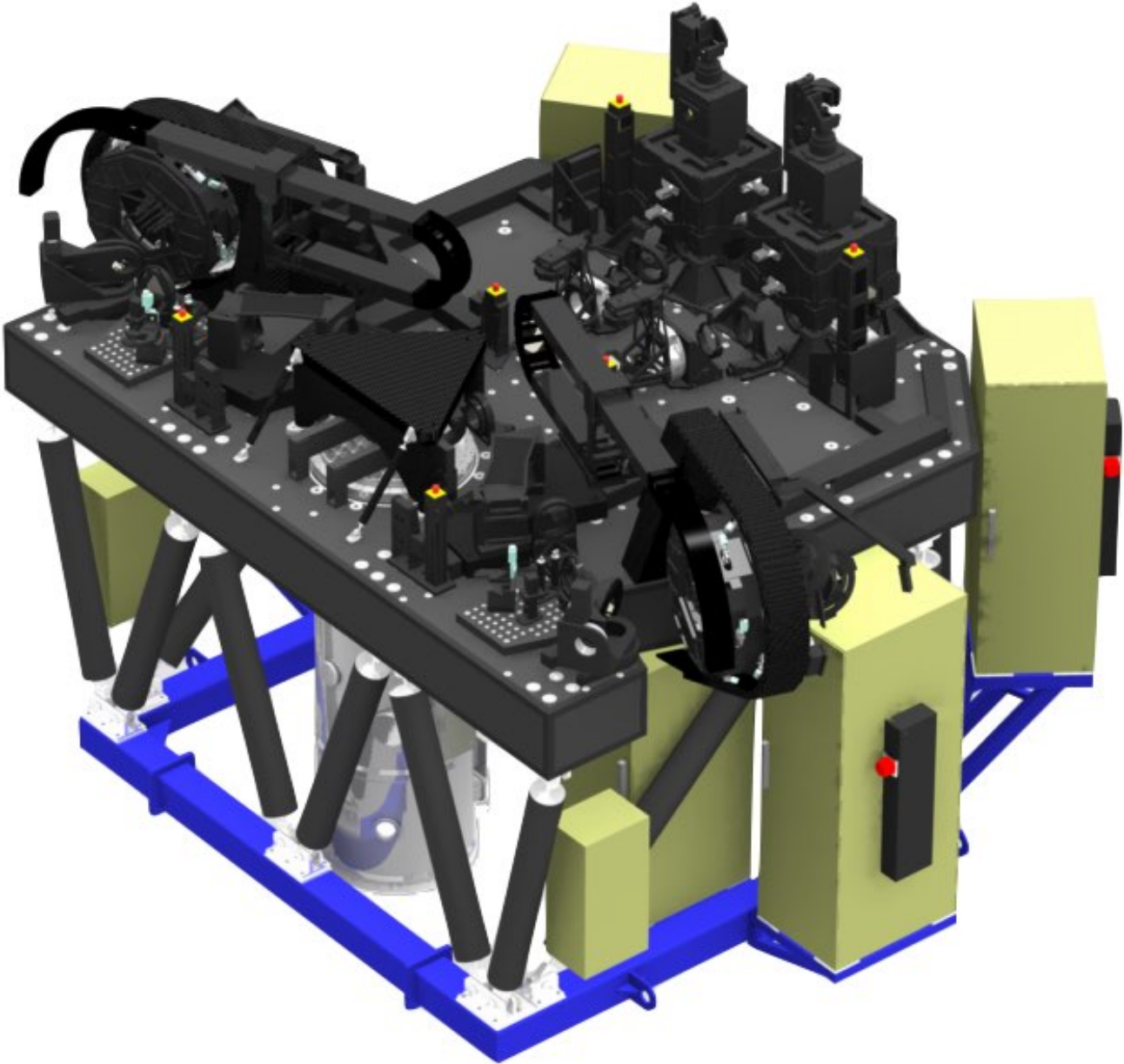

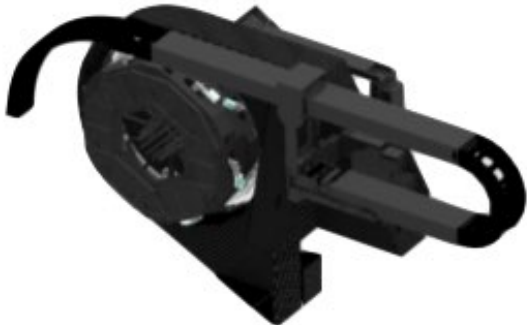

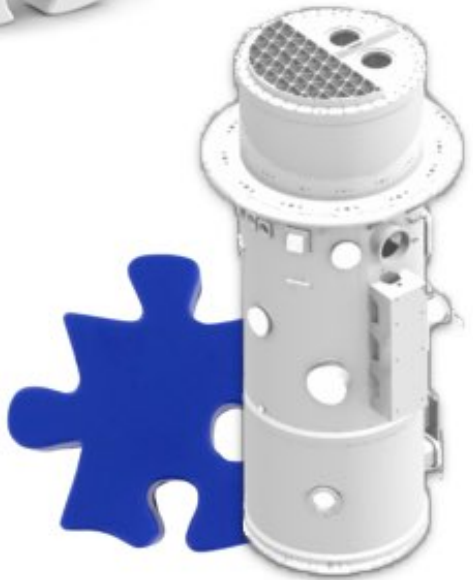

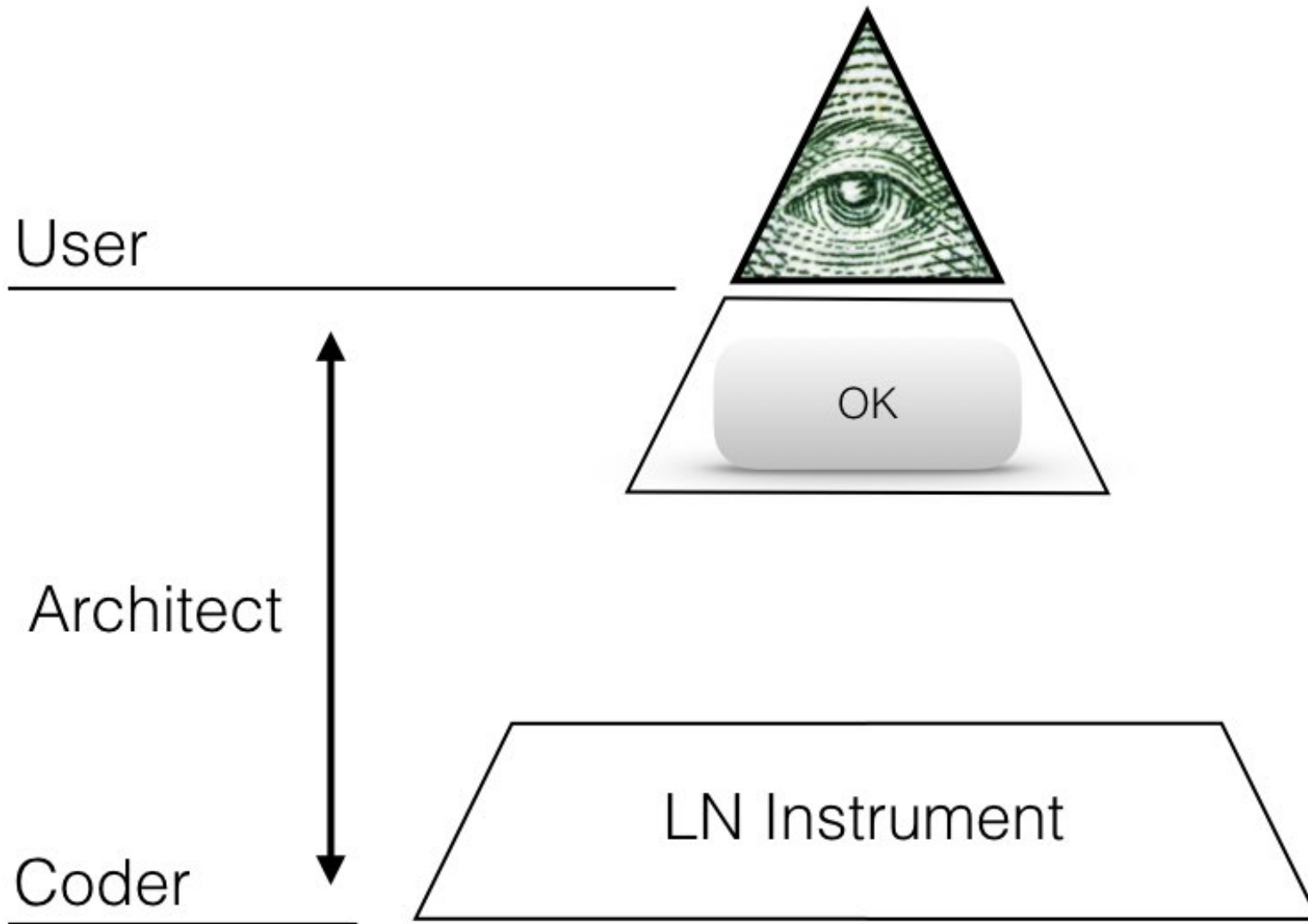

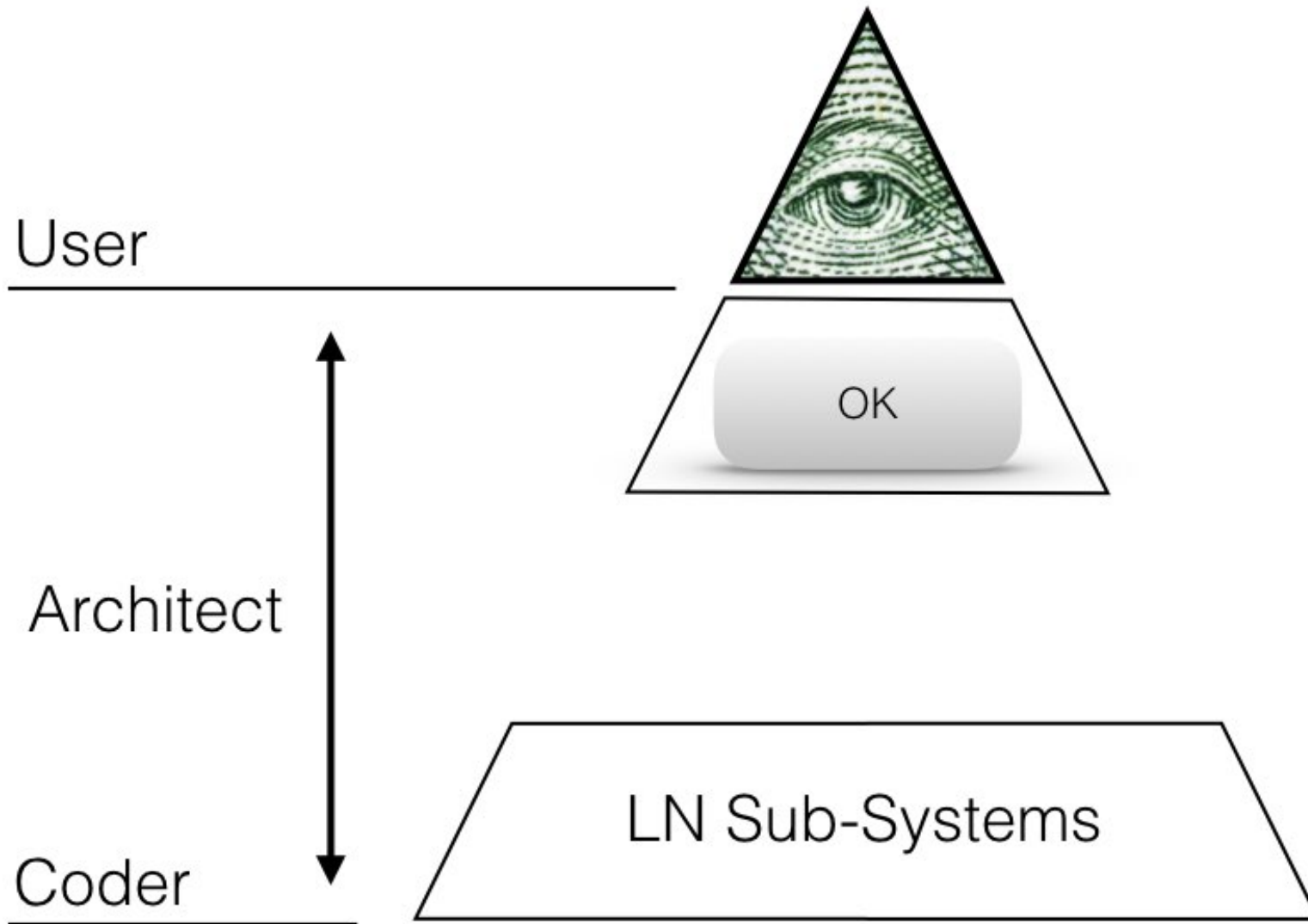

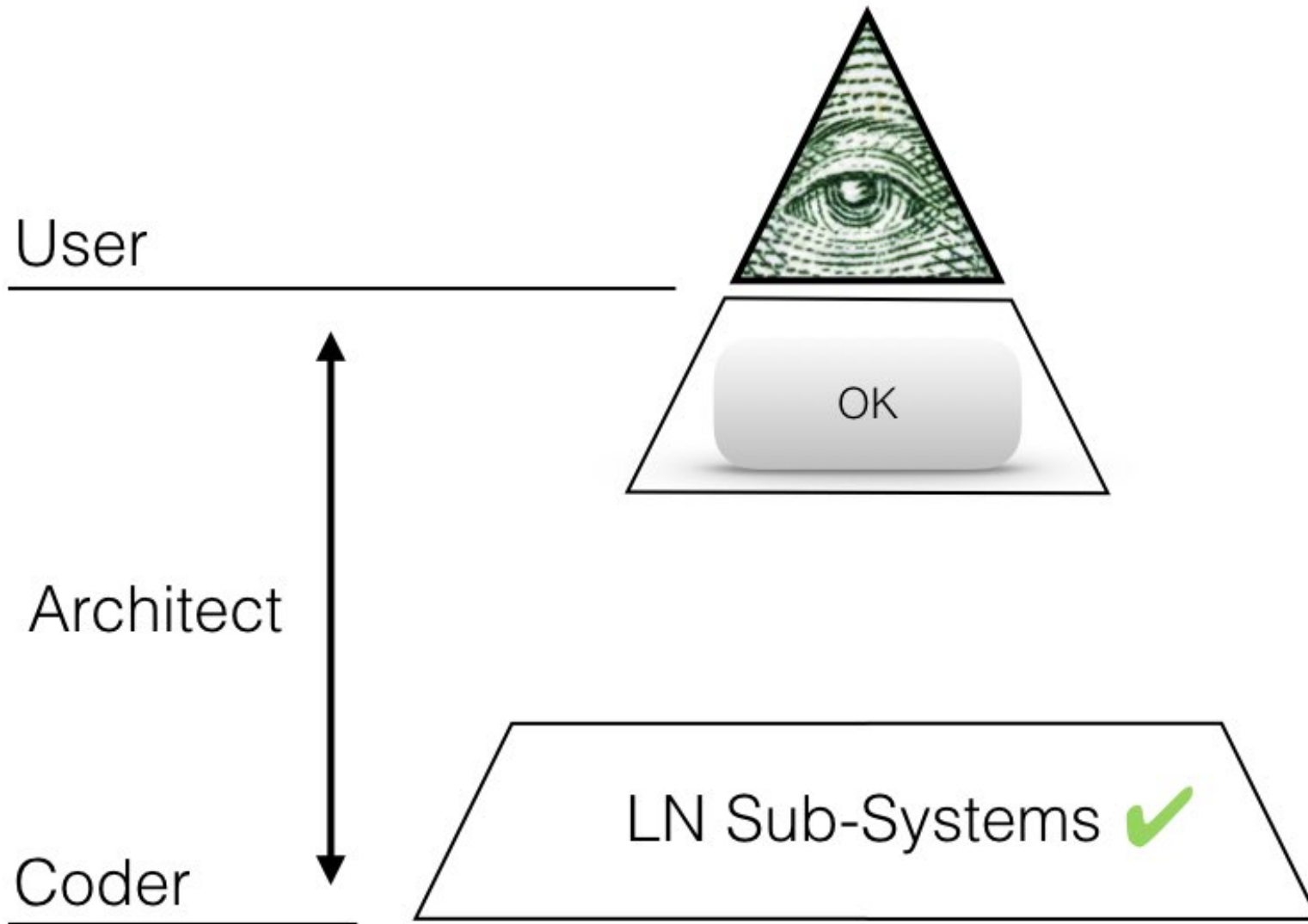

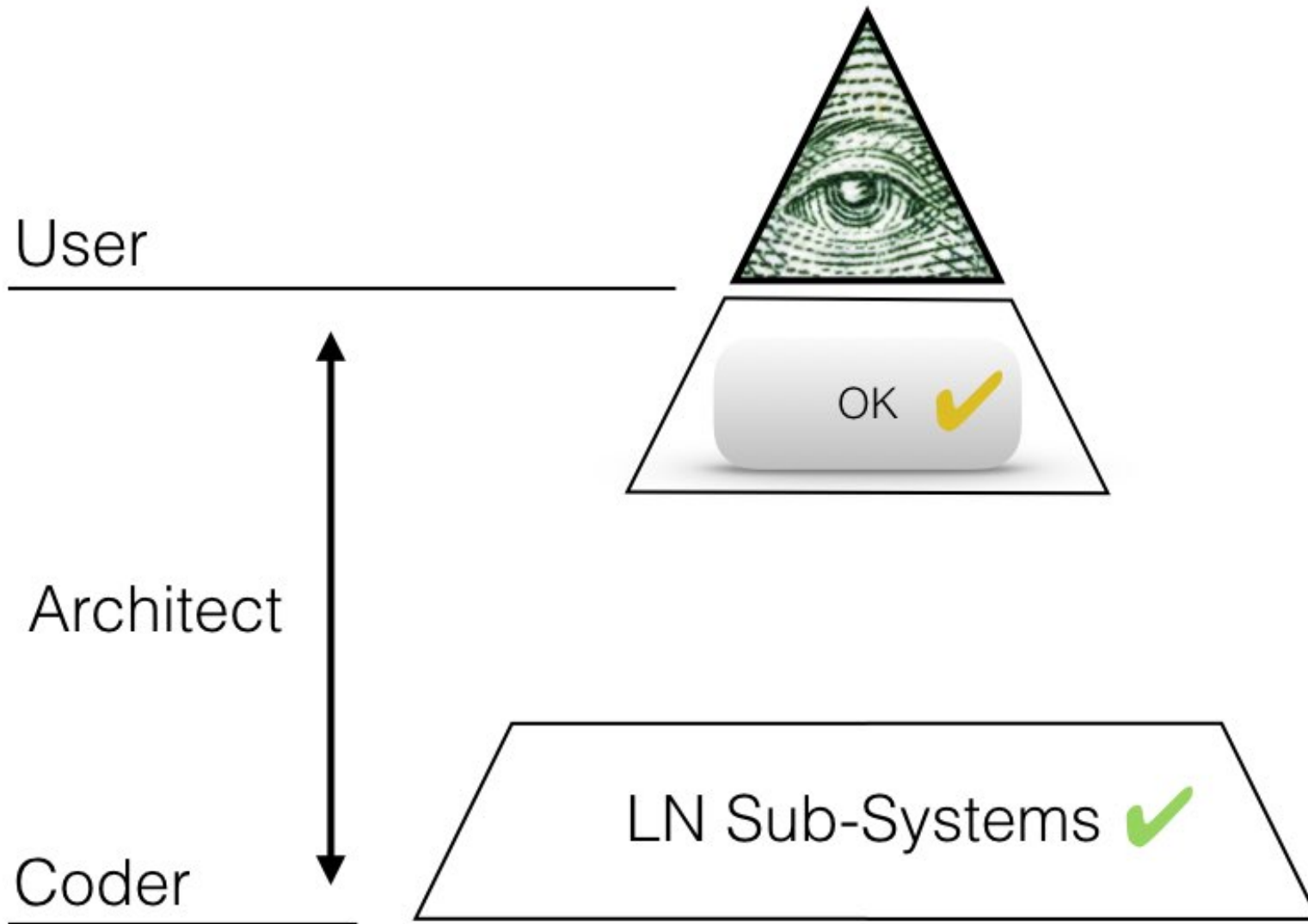

User

Architect

Coder

OK

LN Sub-Systems

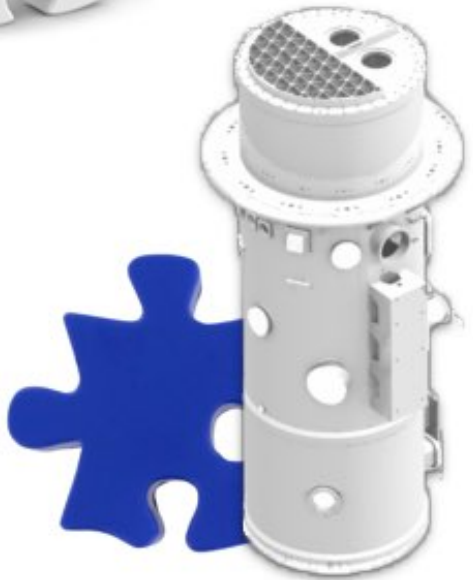

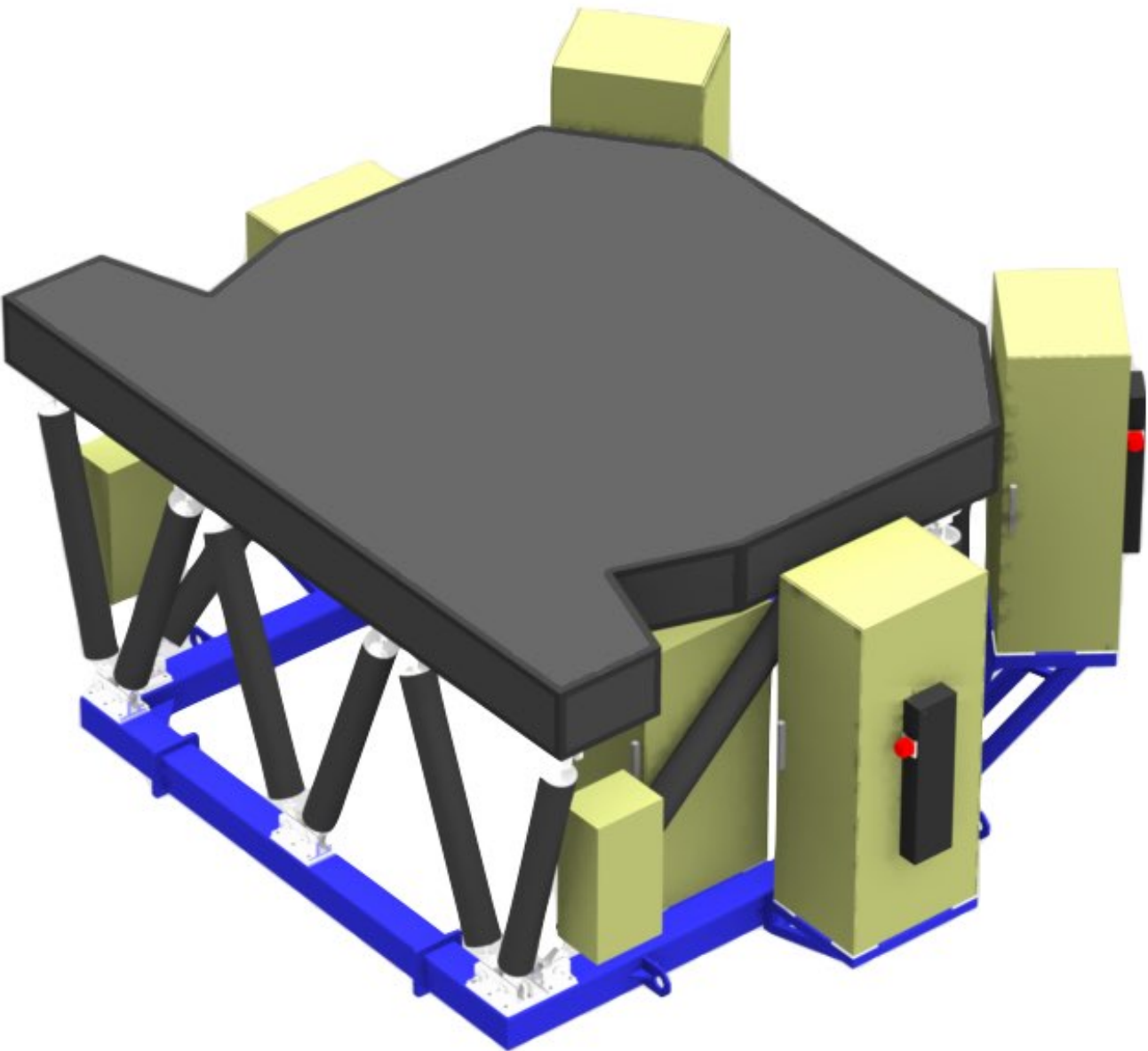

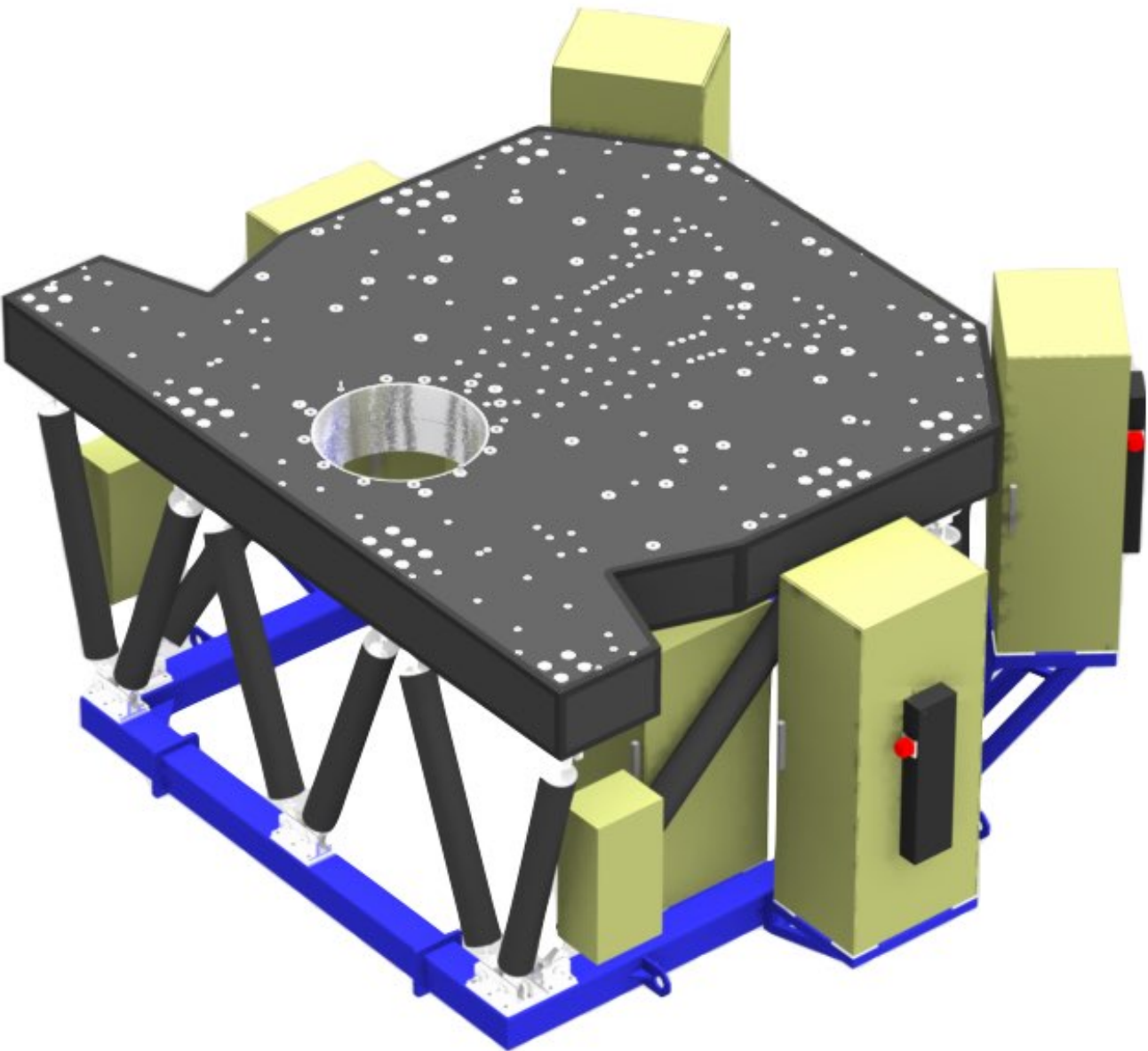

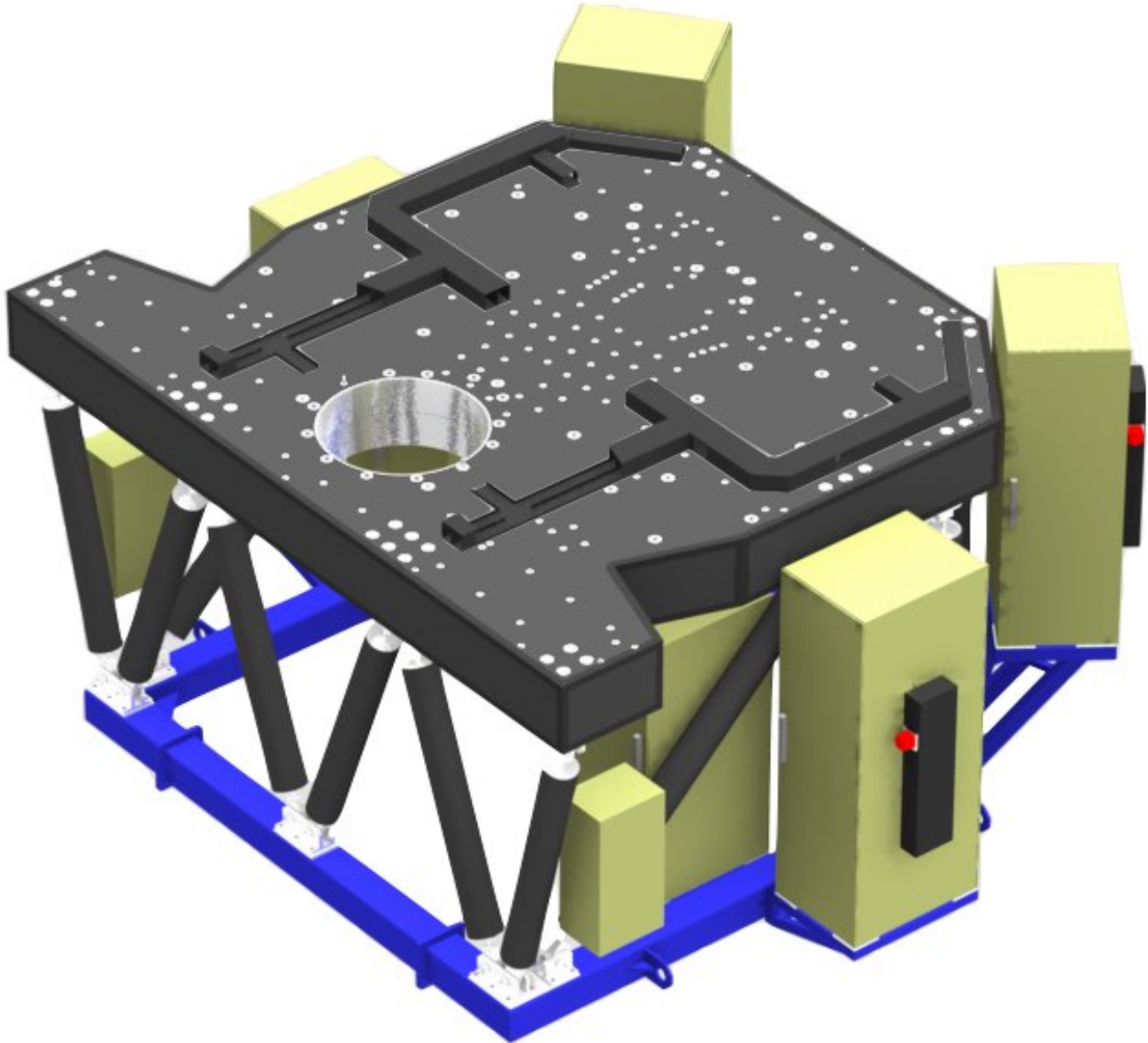

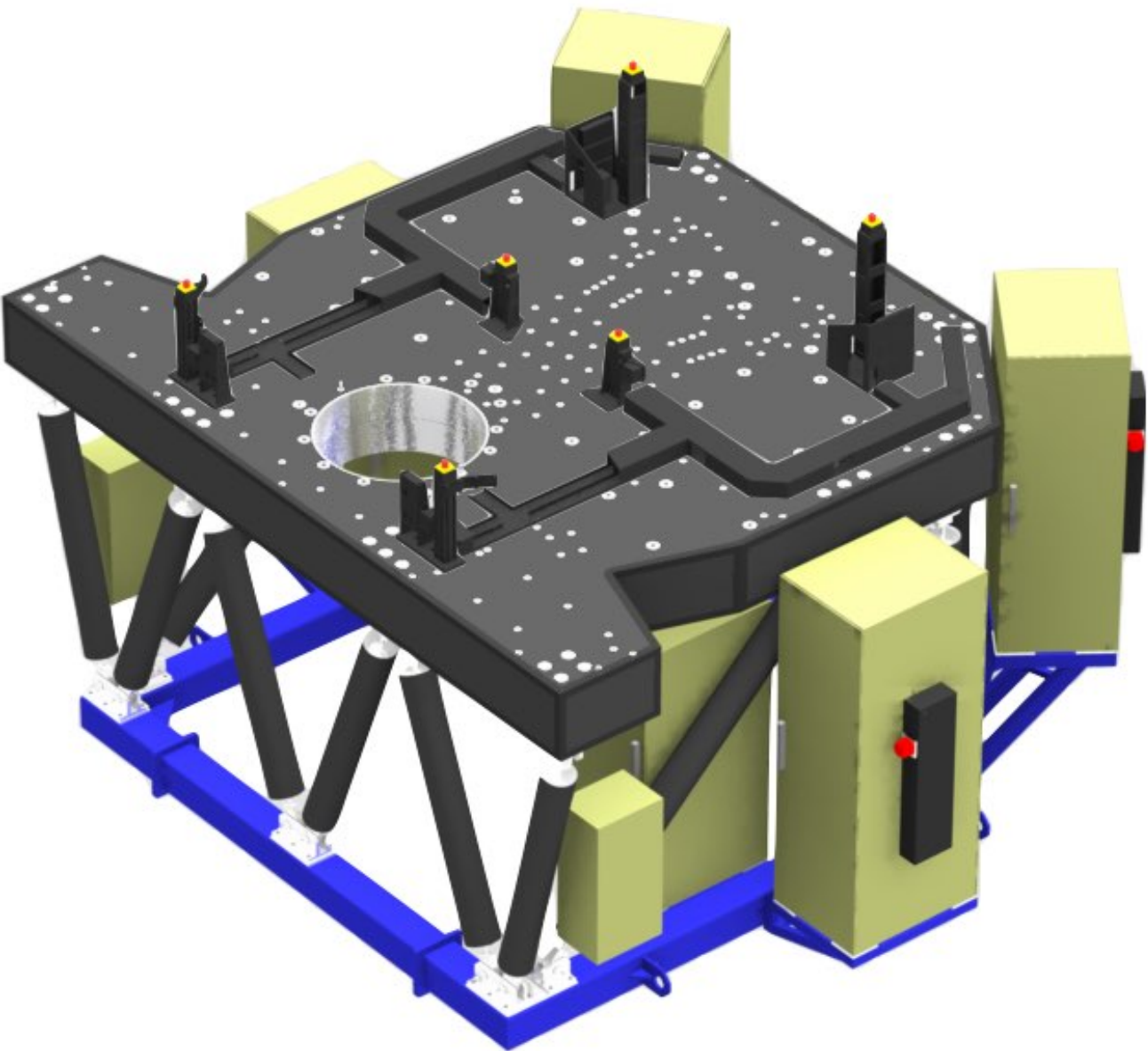

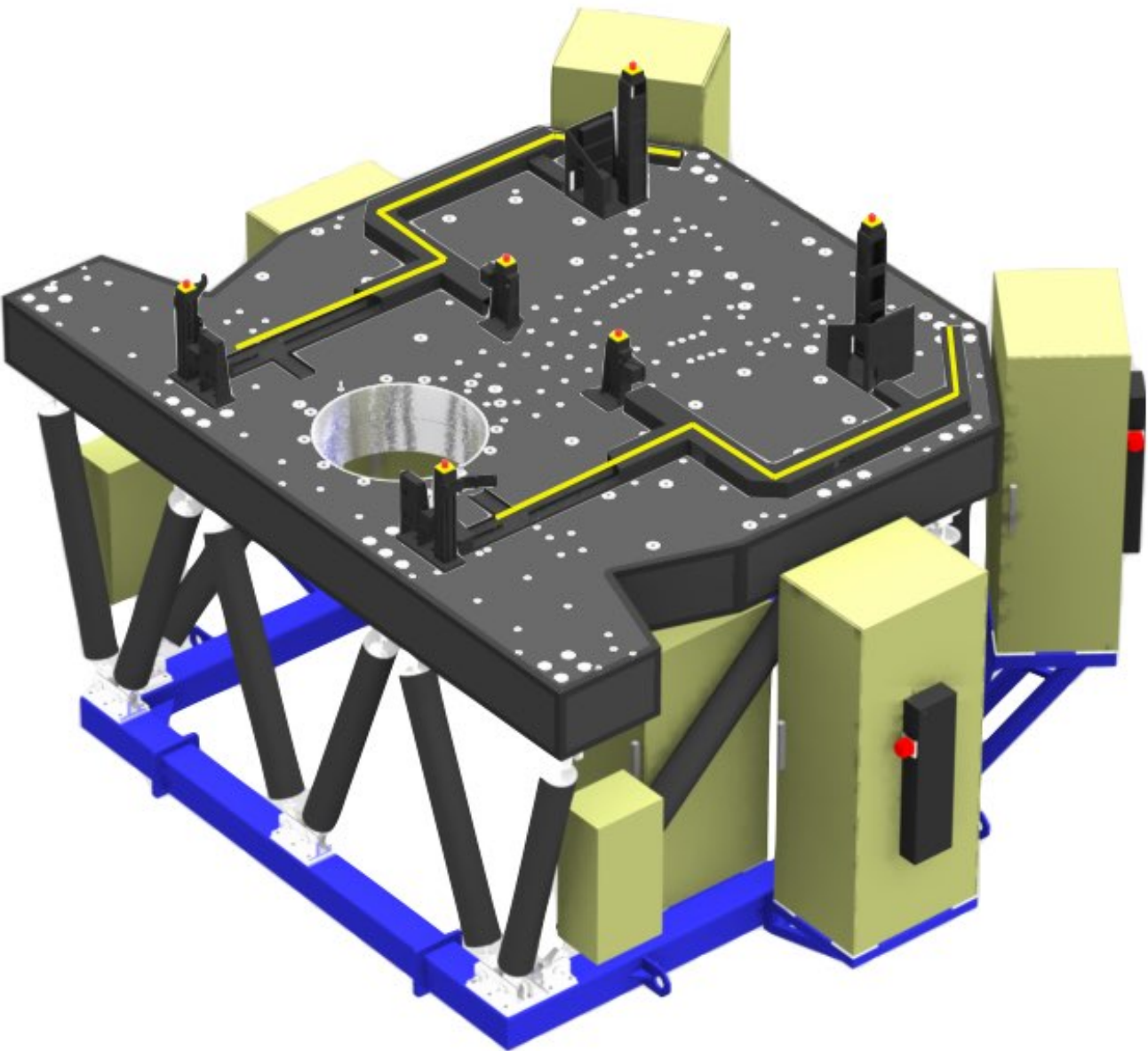

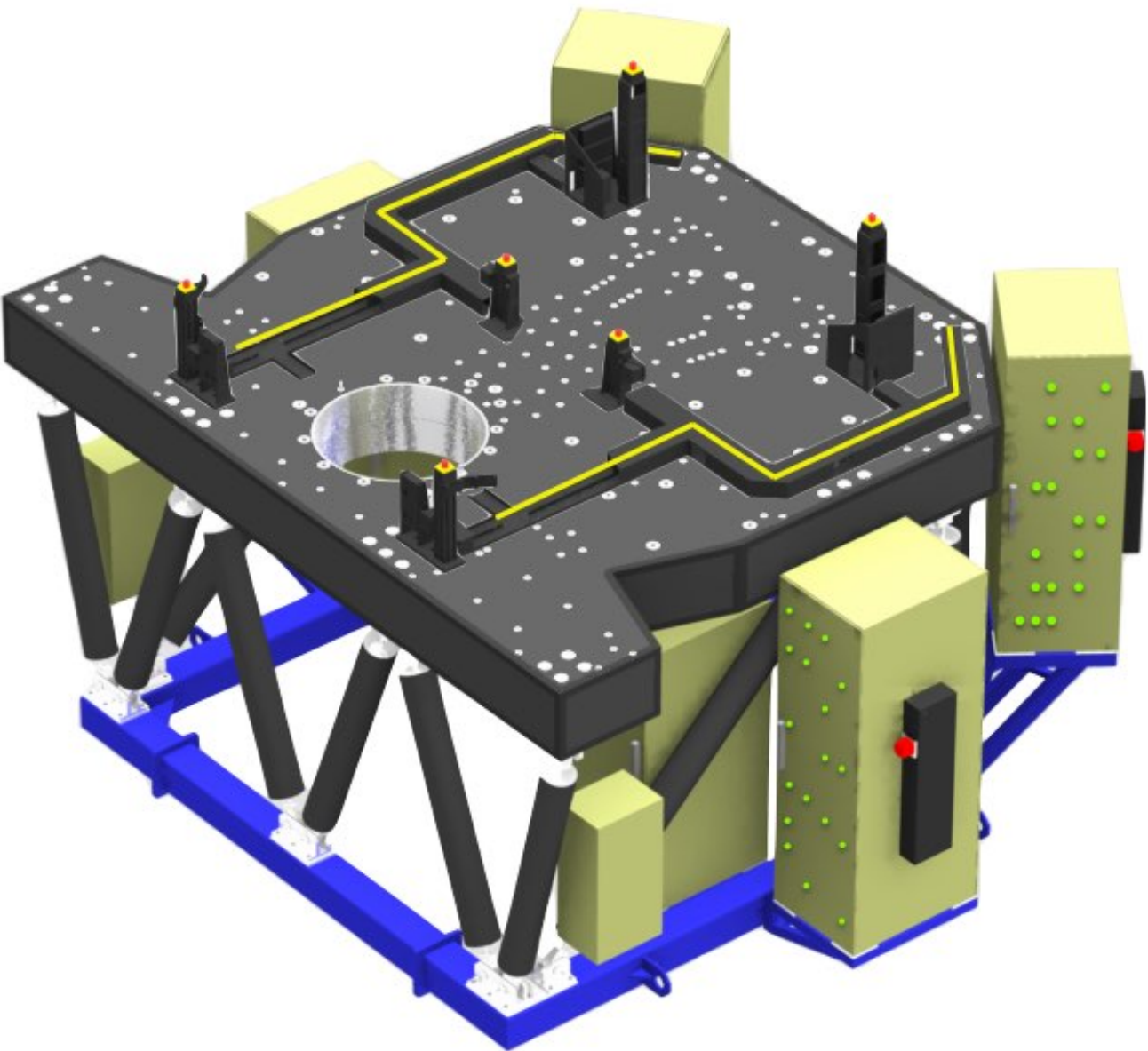

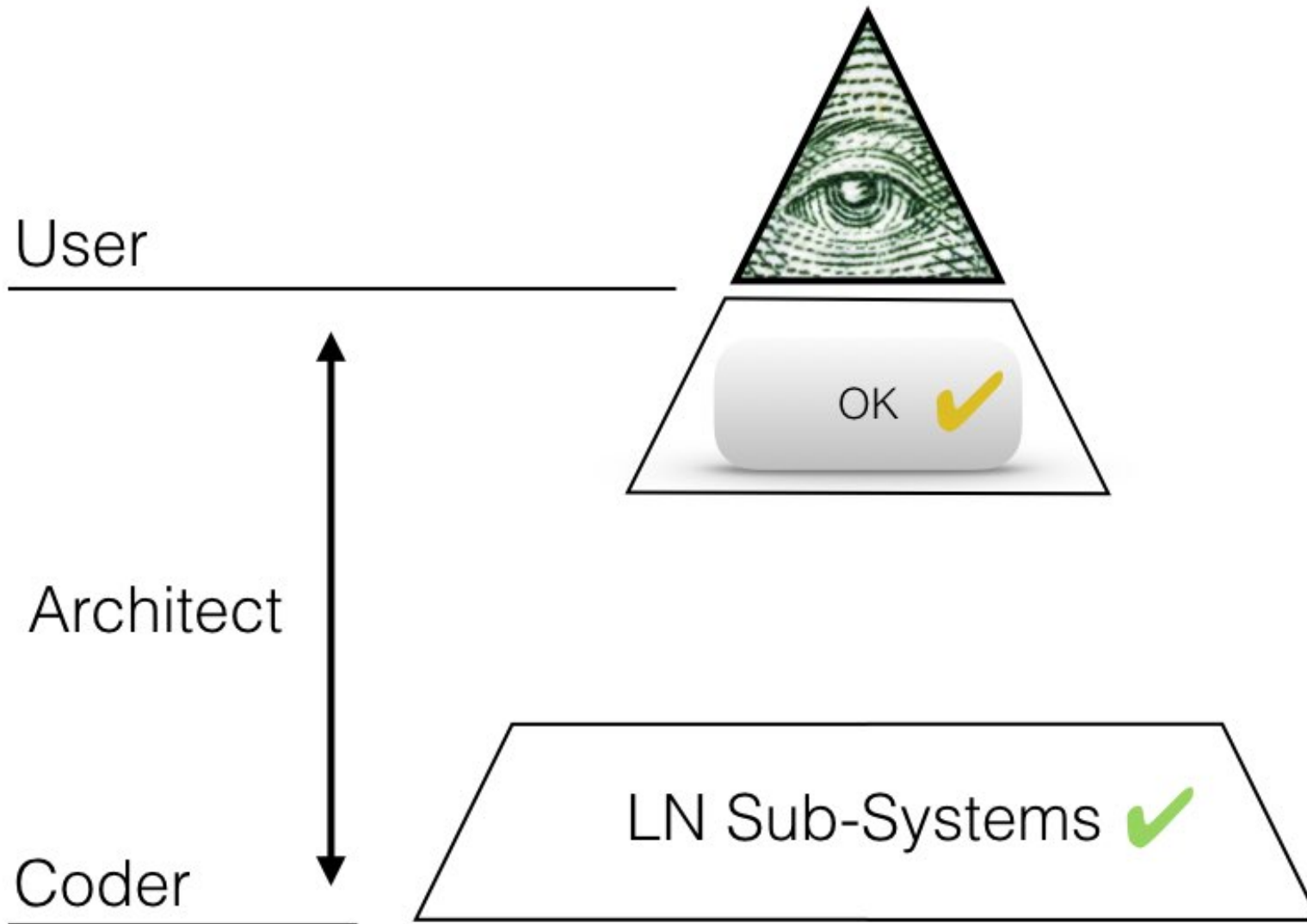

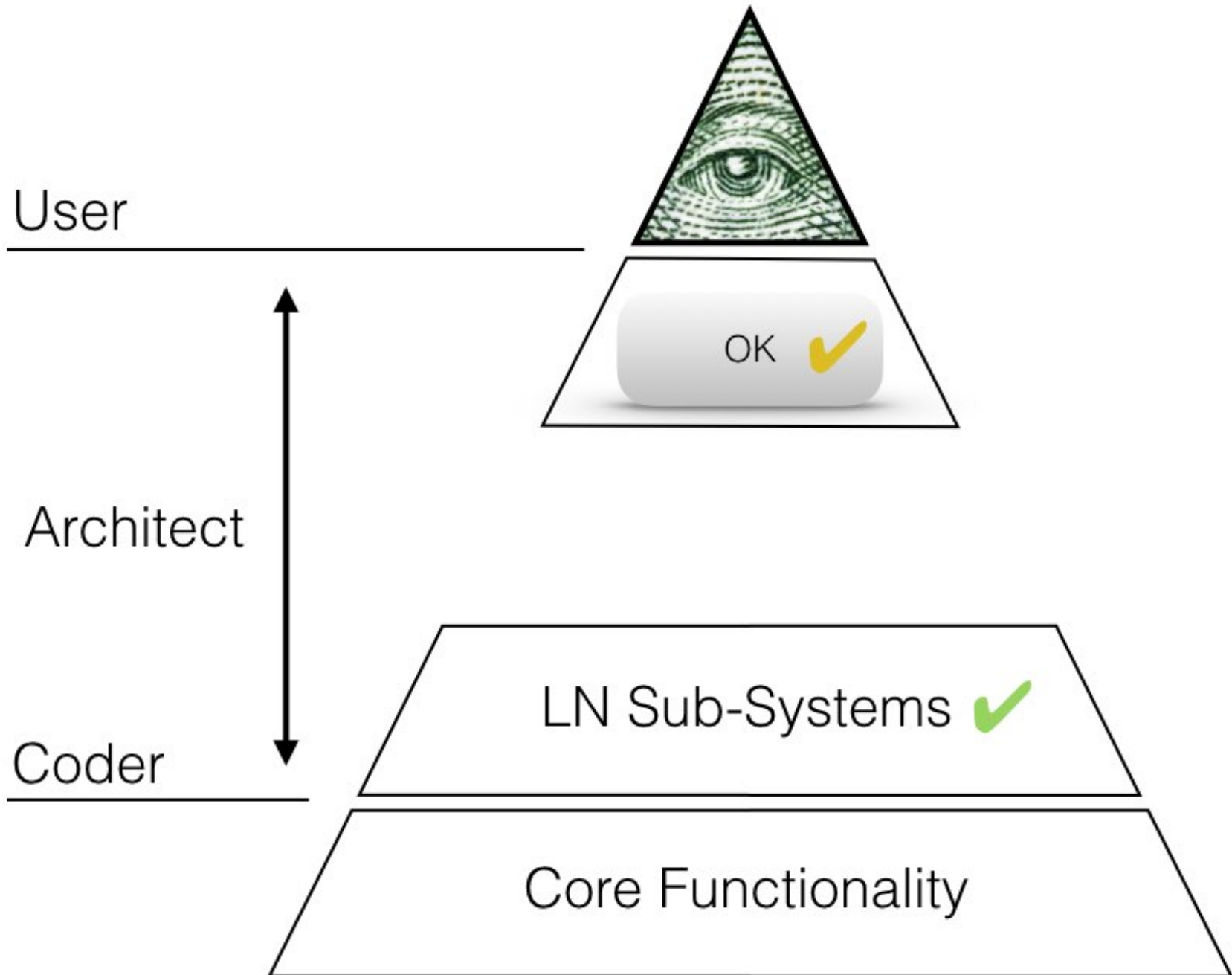

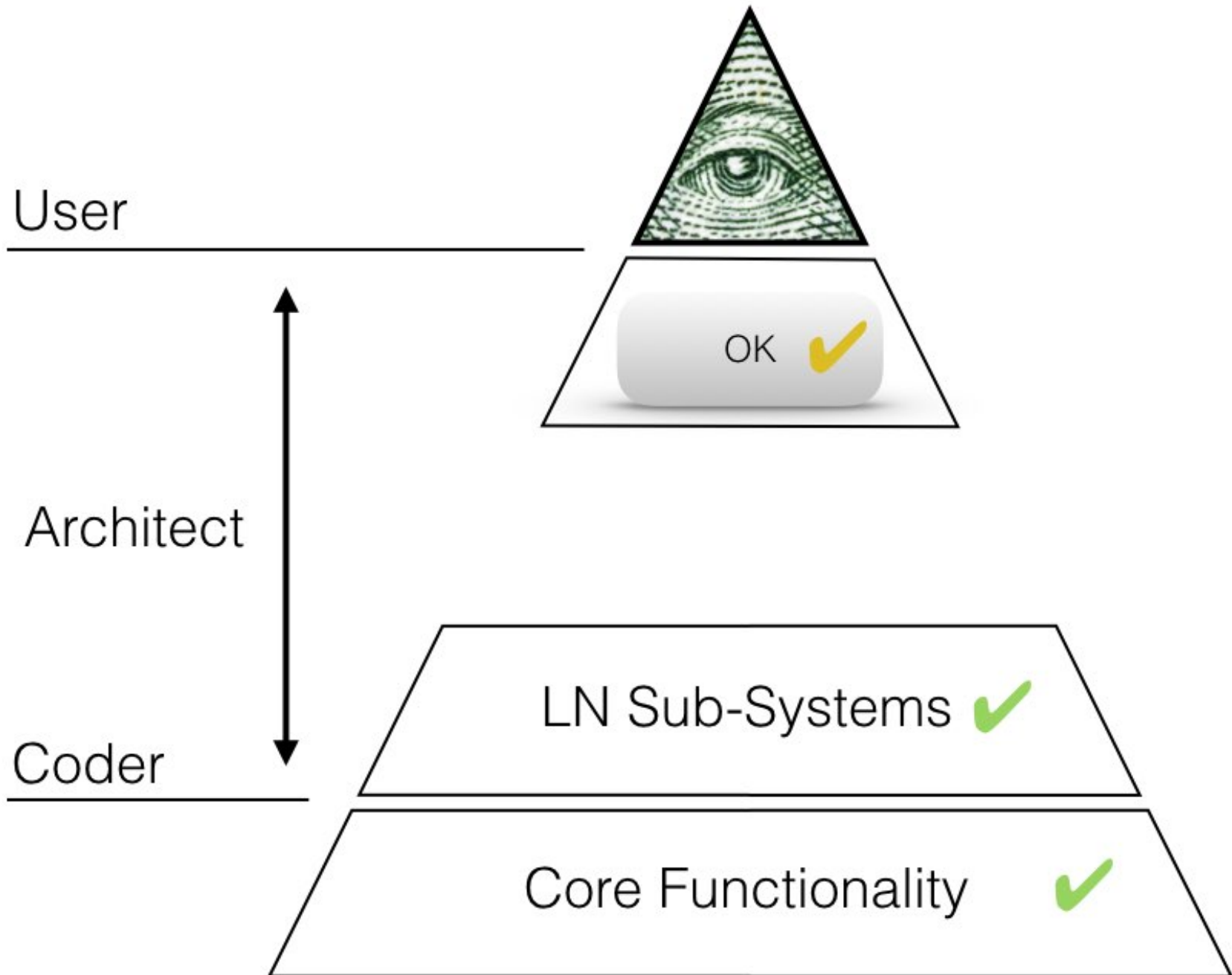

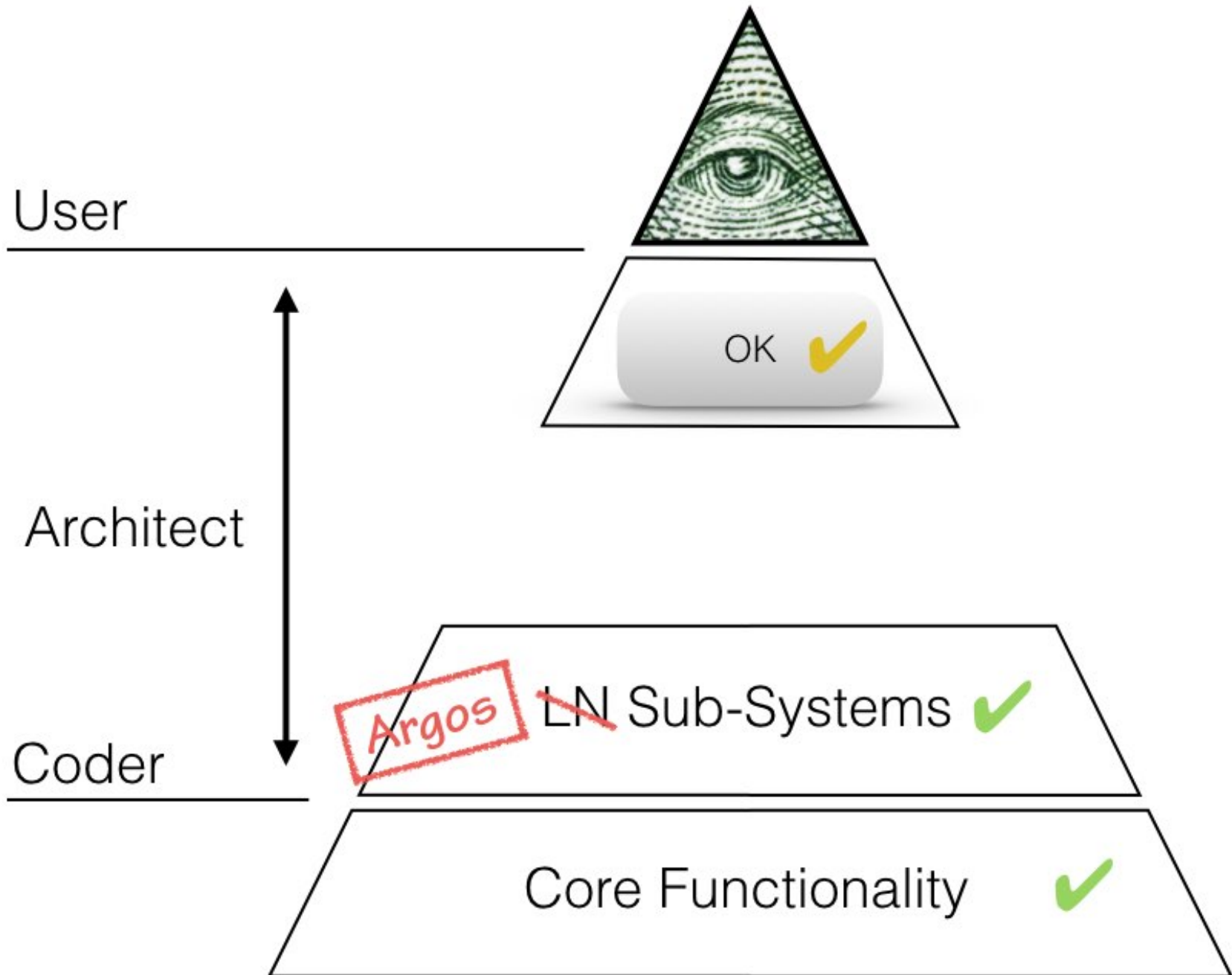



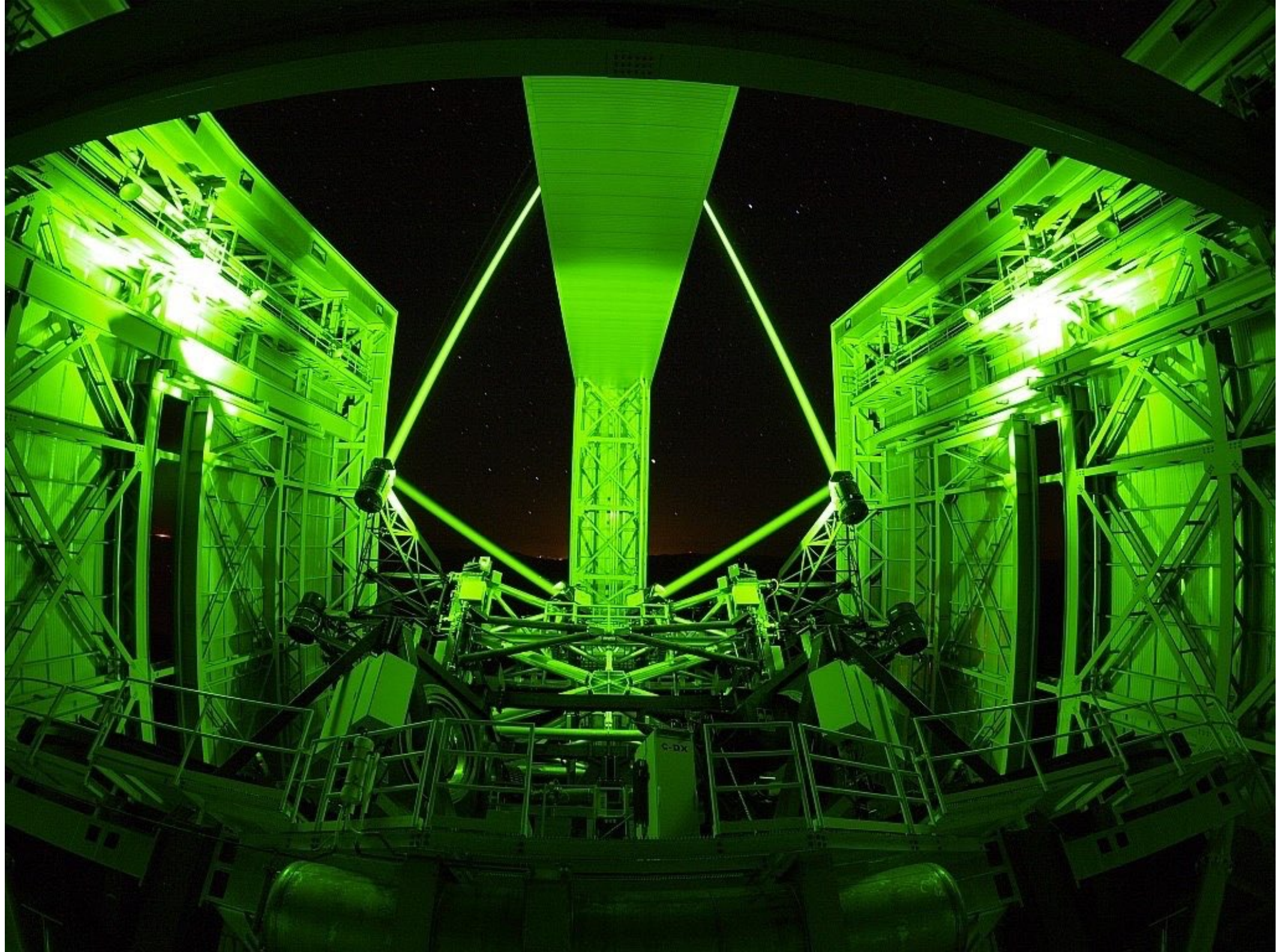

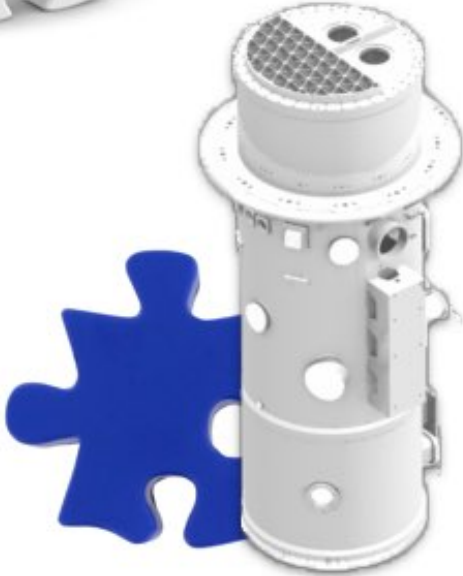



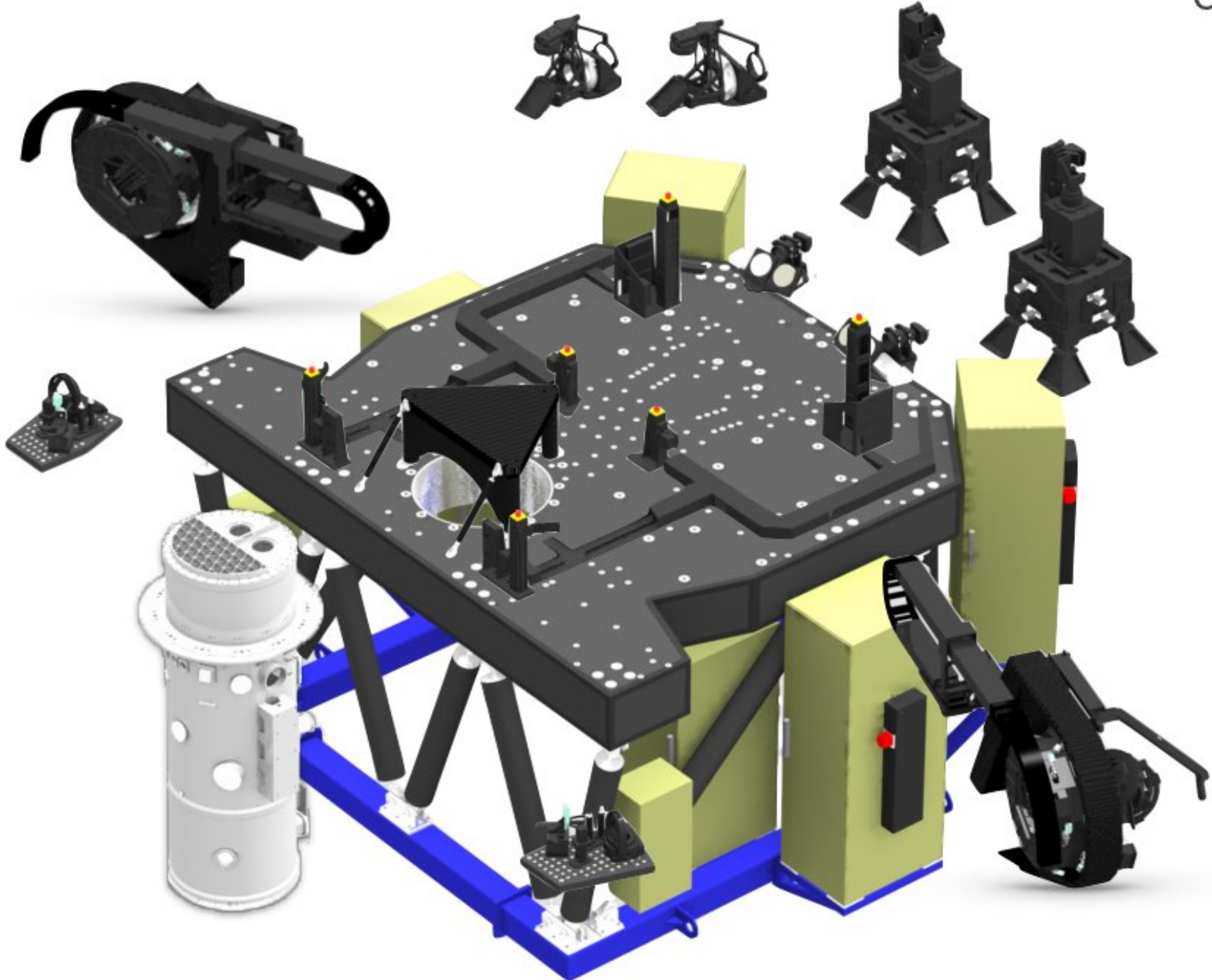

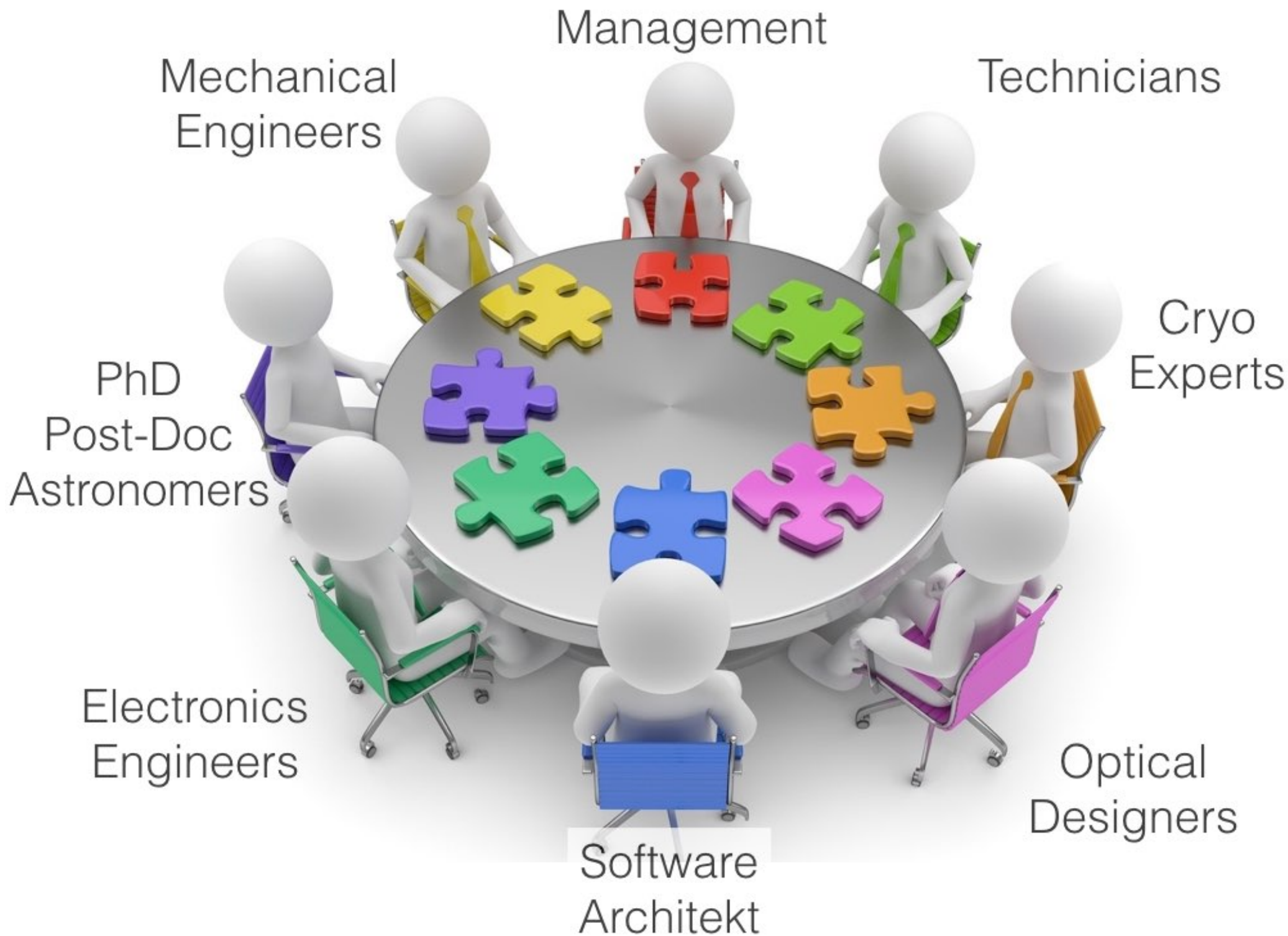

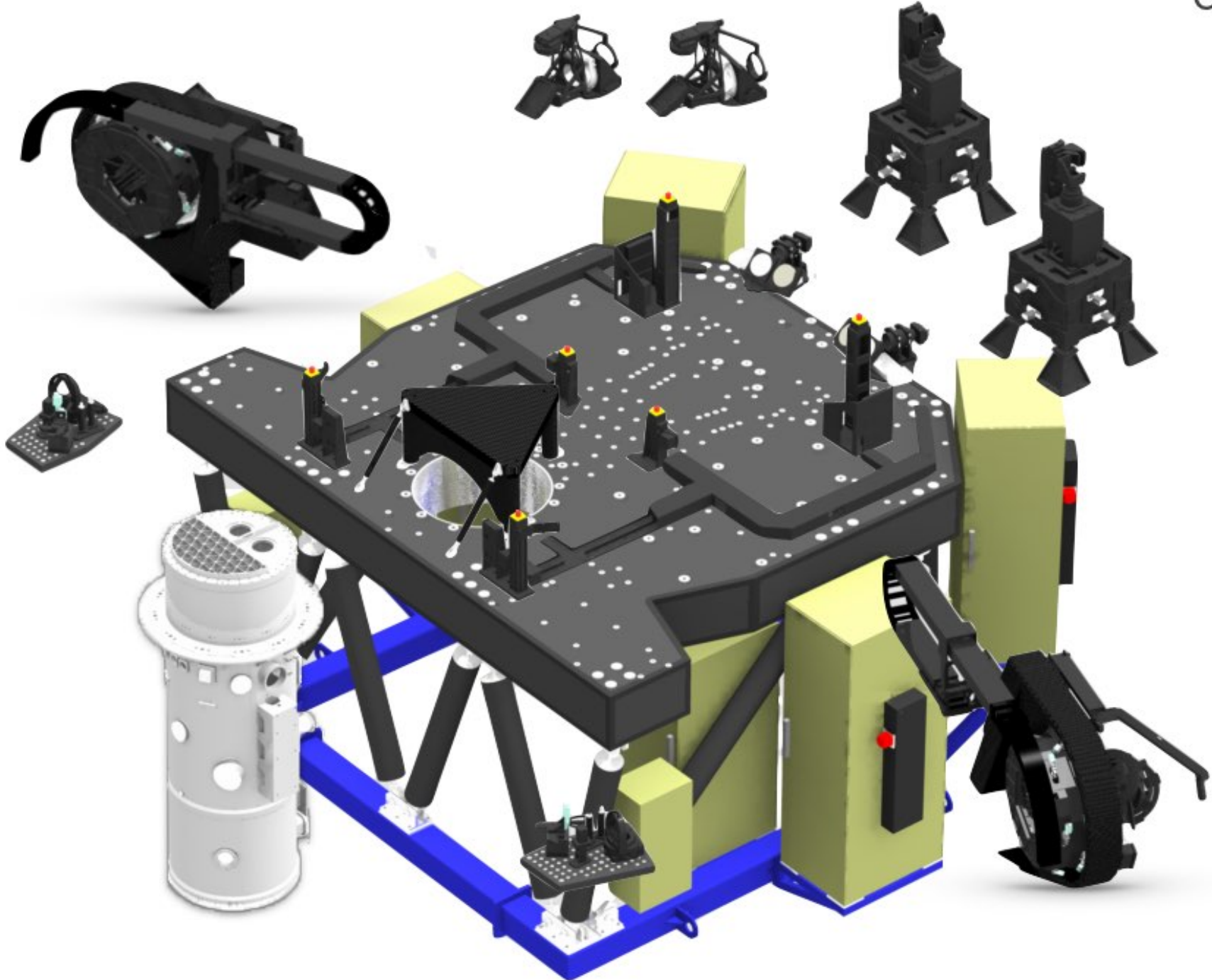

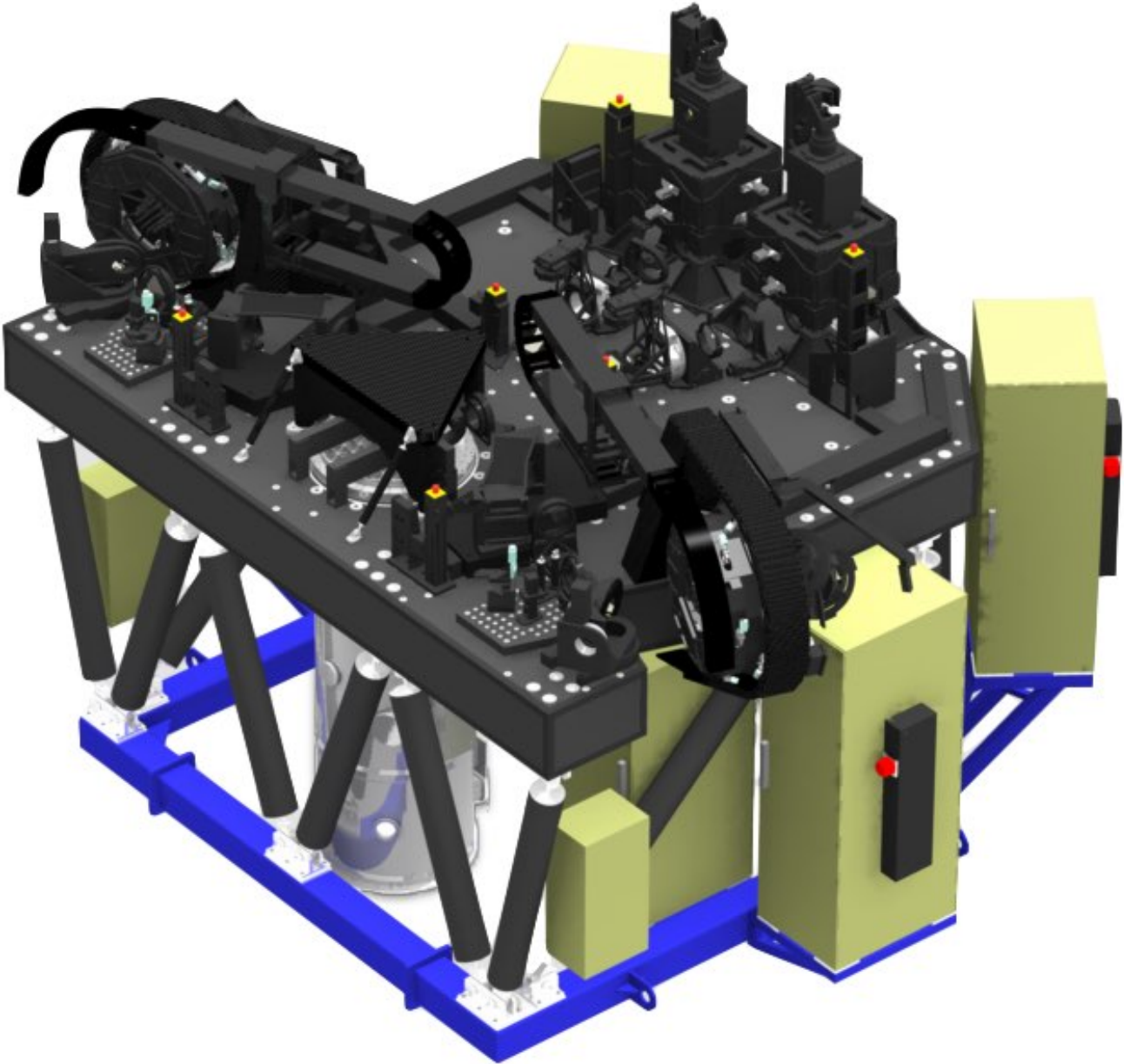

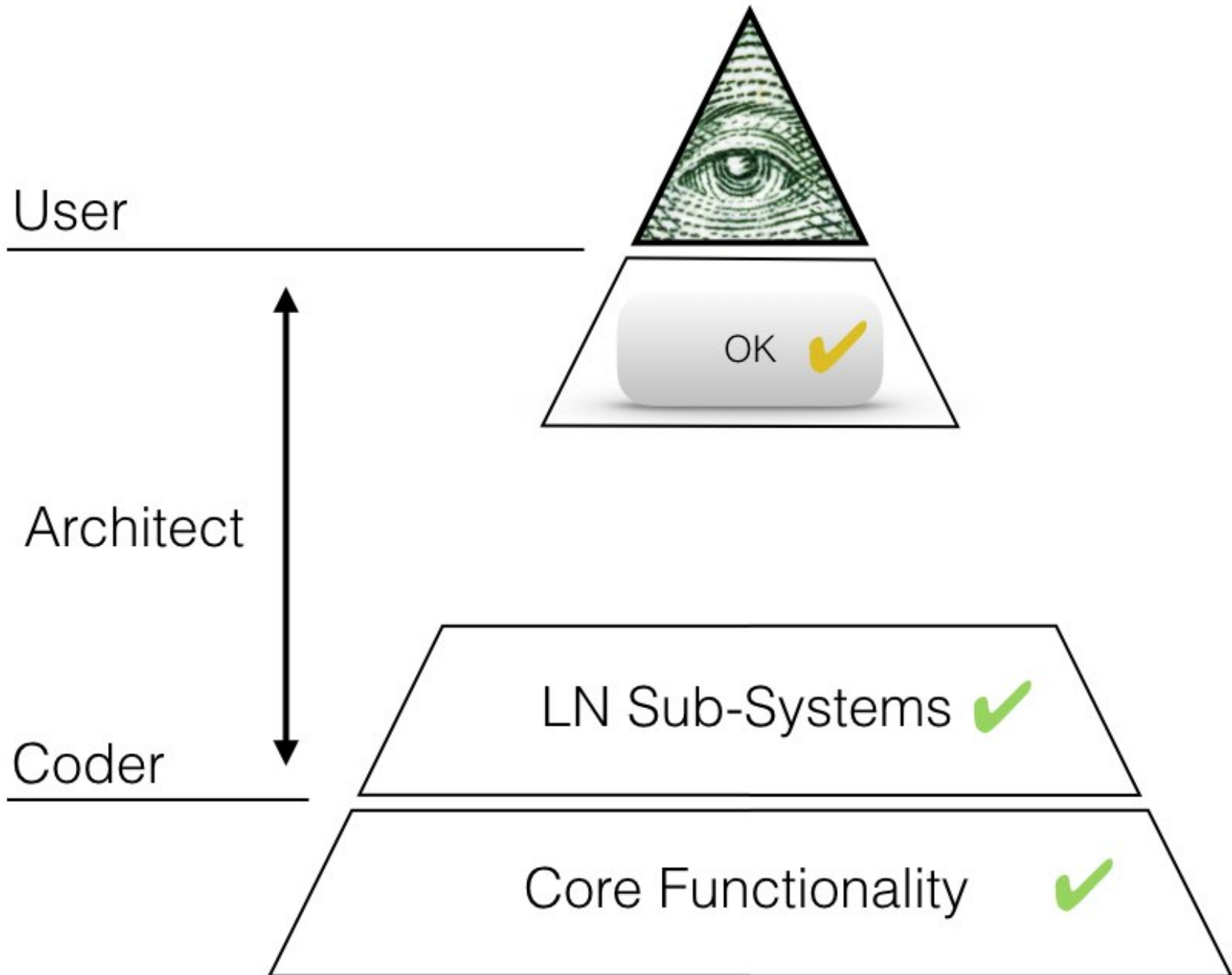

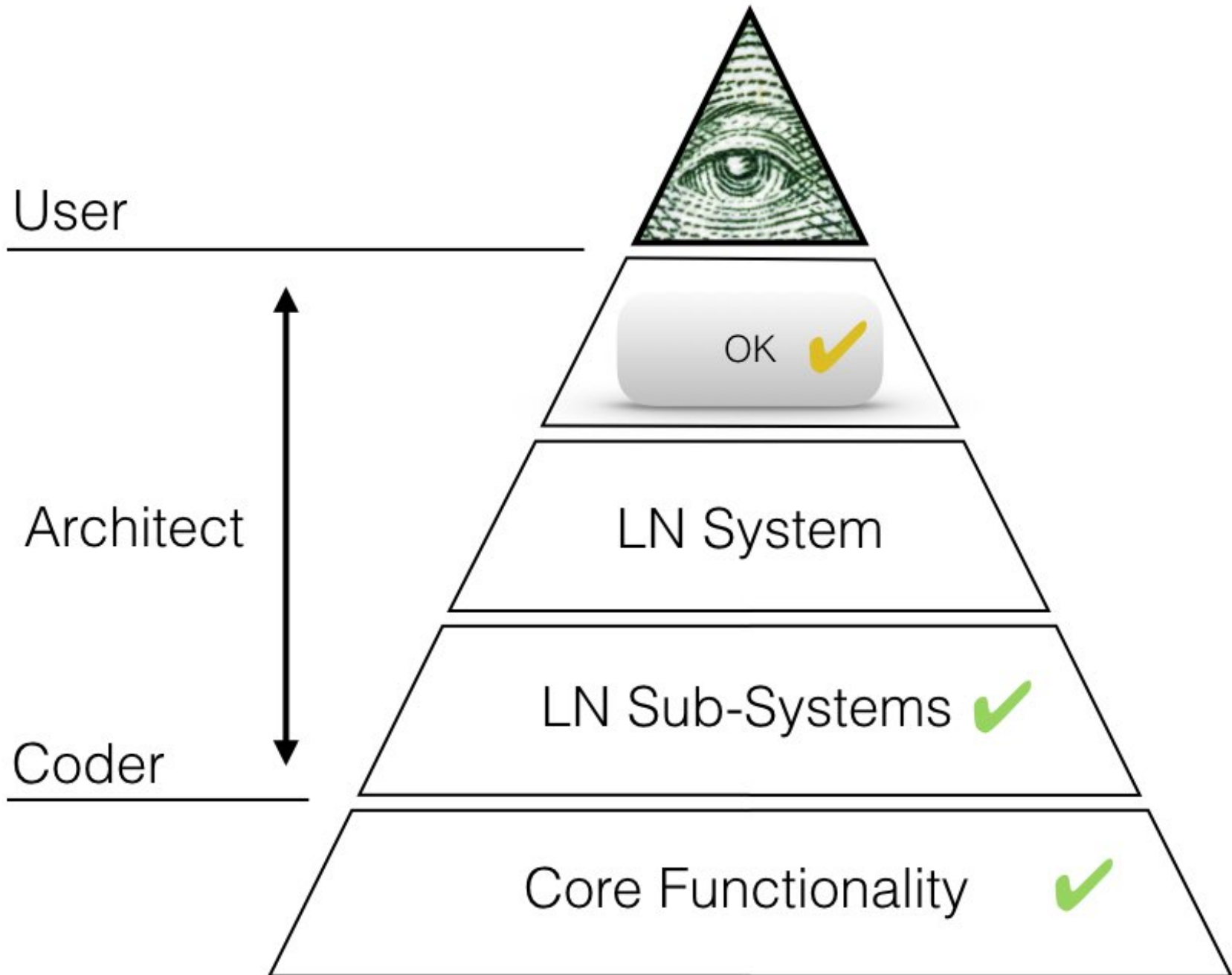

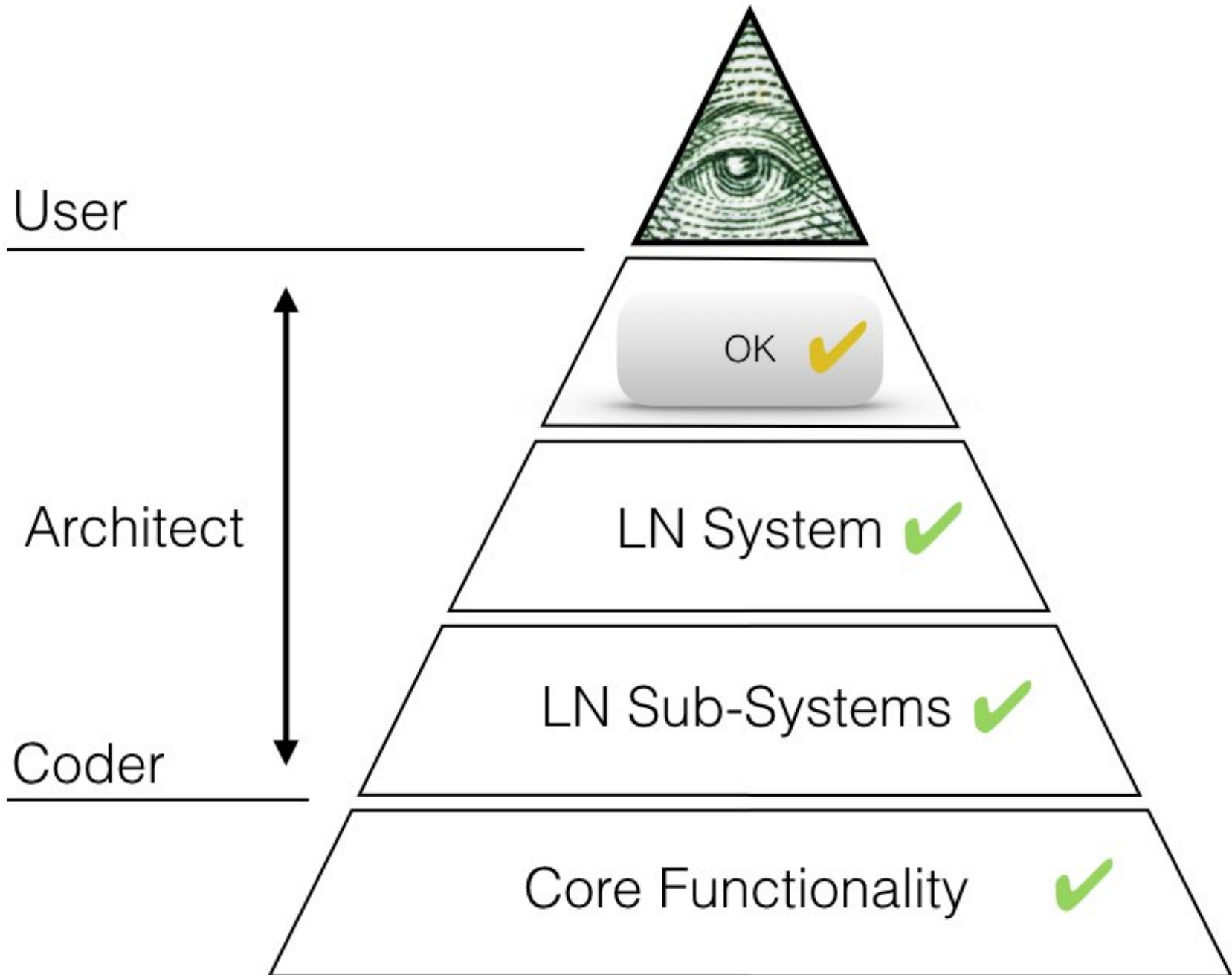

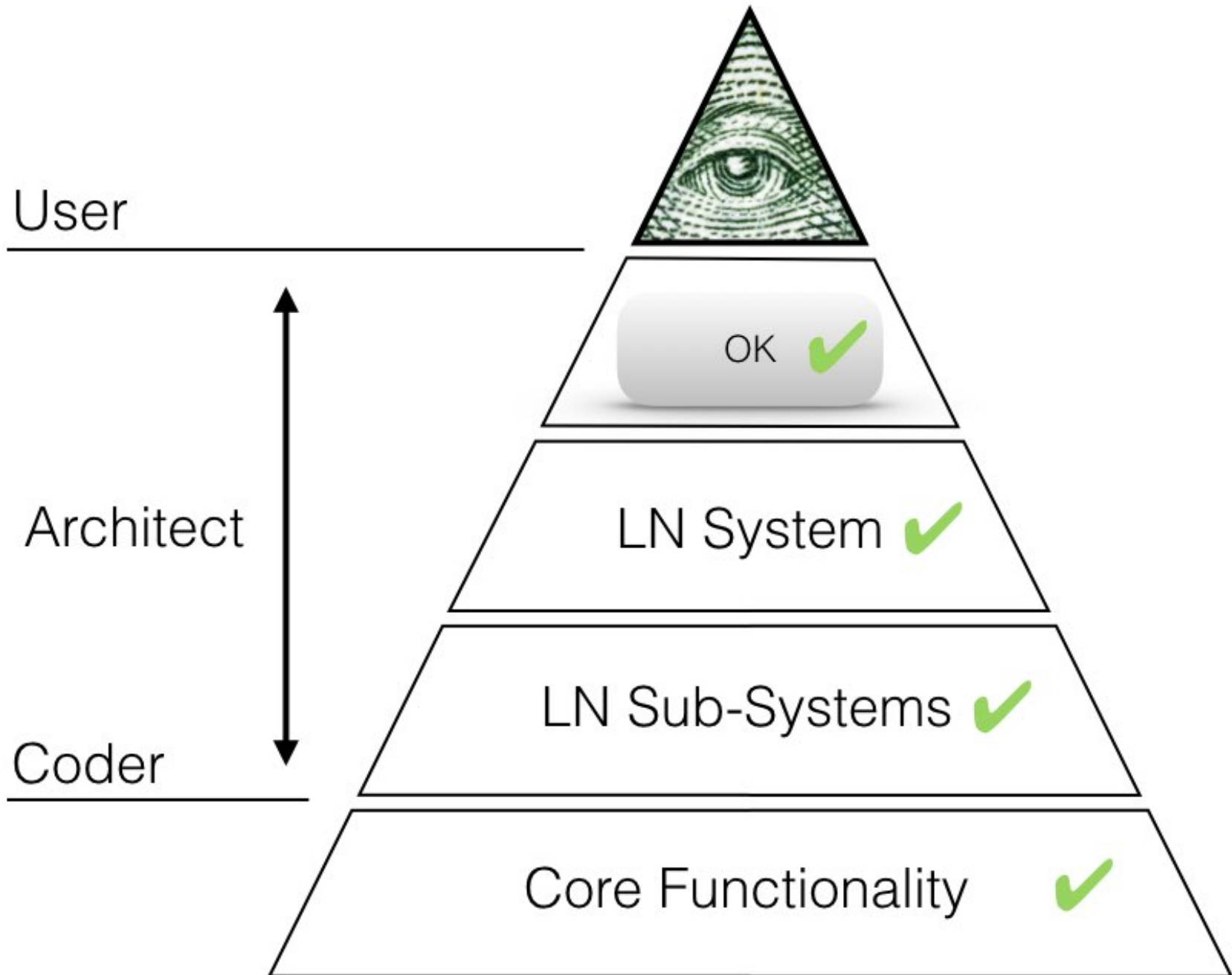



42

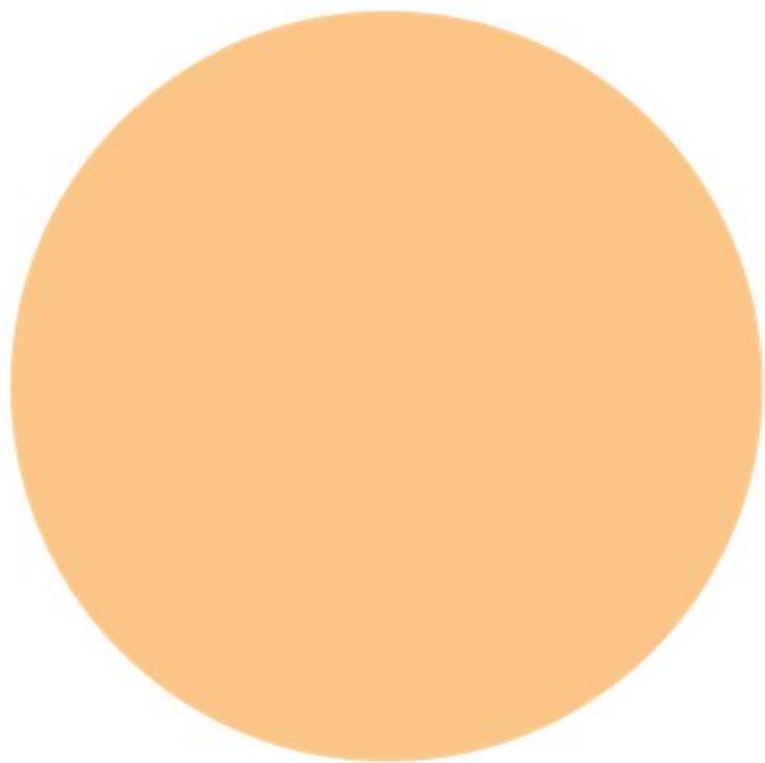

42

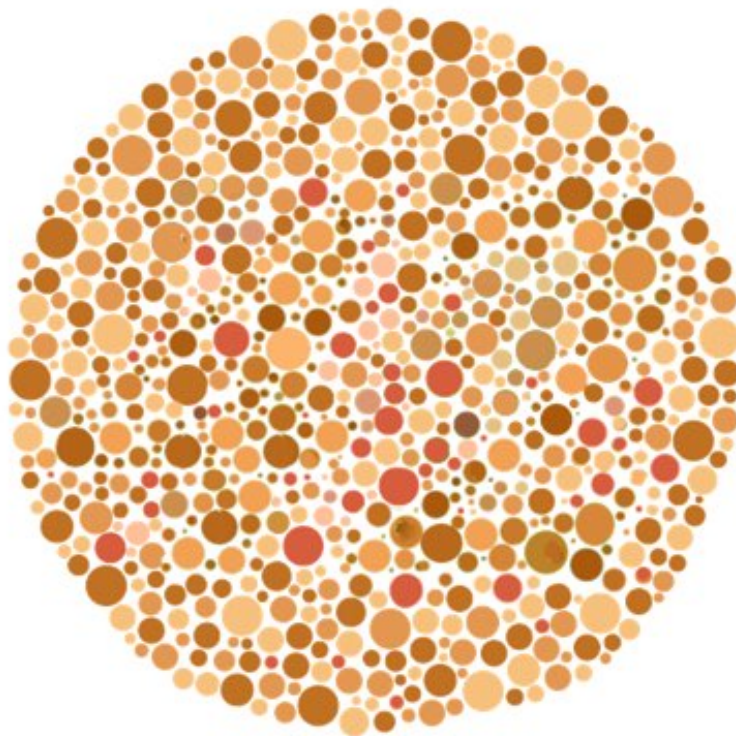
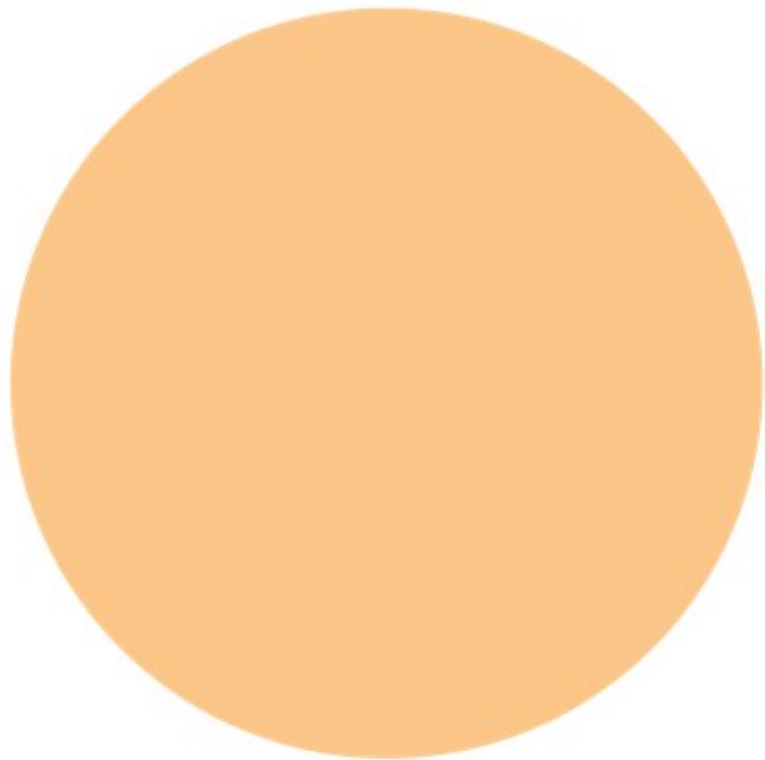

Tester

42

Tester

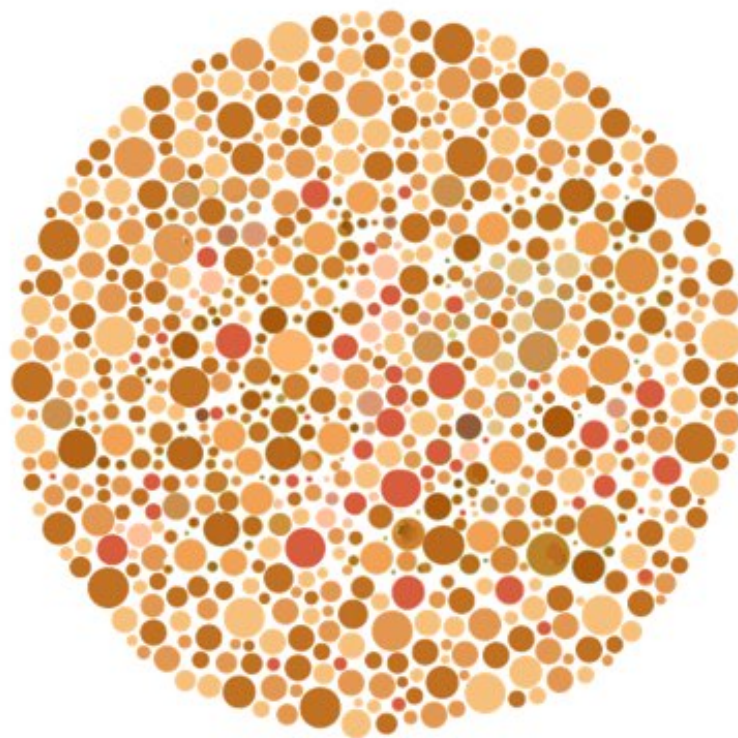
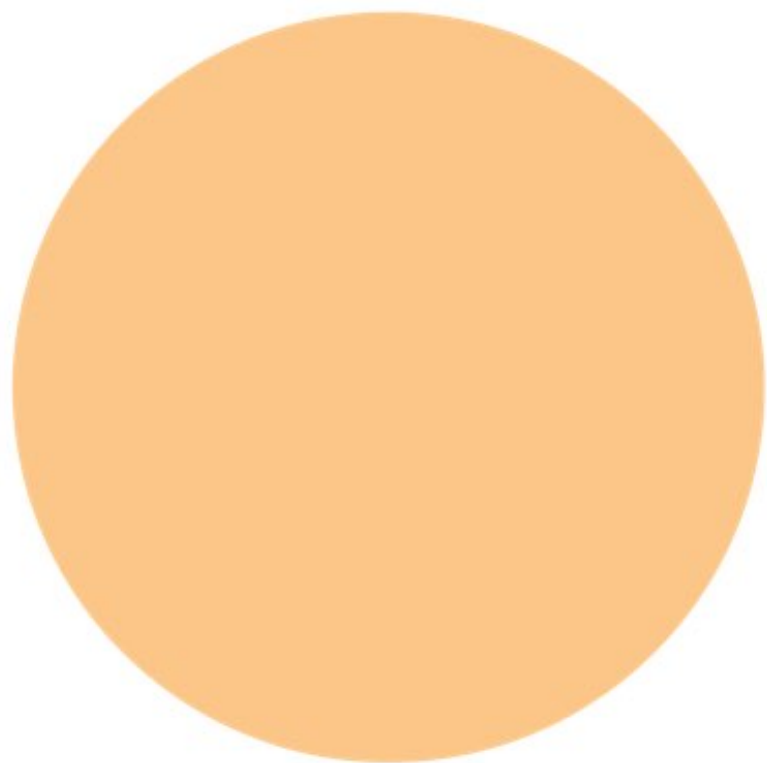

42



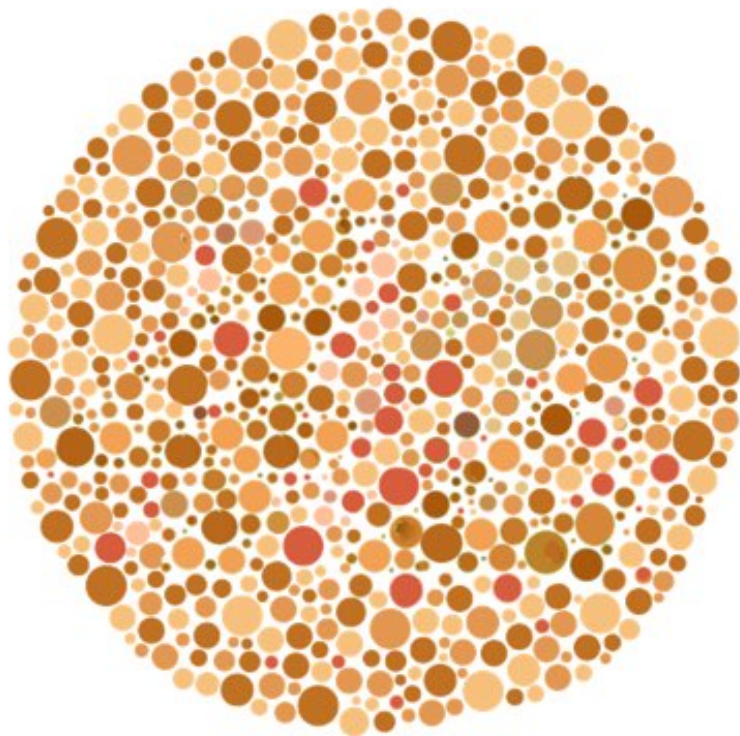
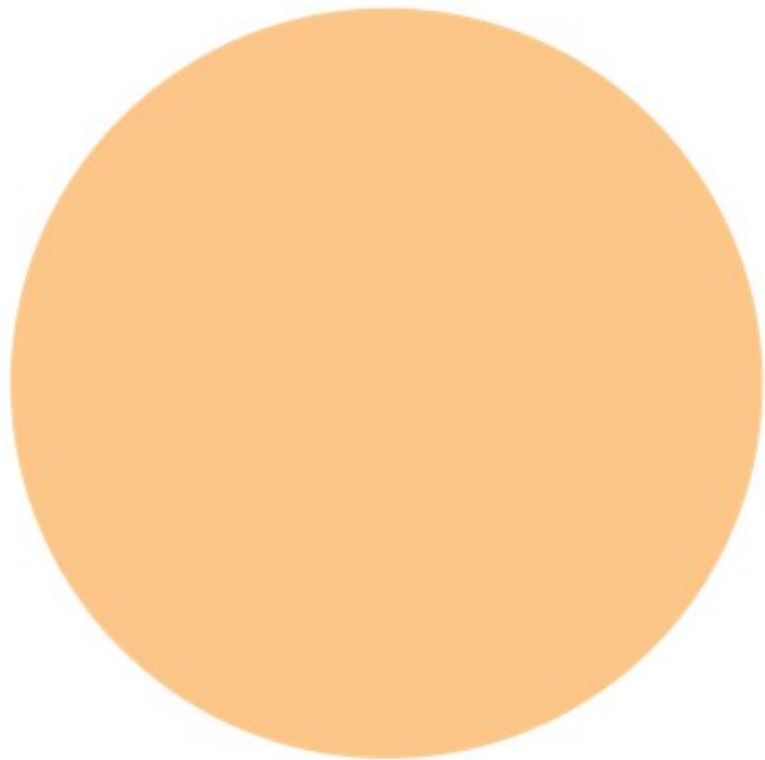

Tester



42



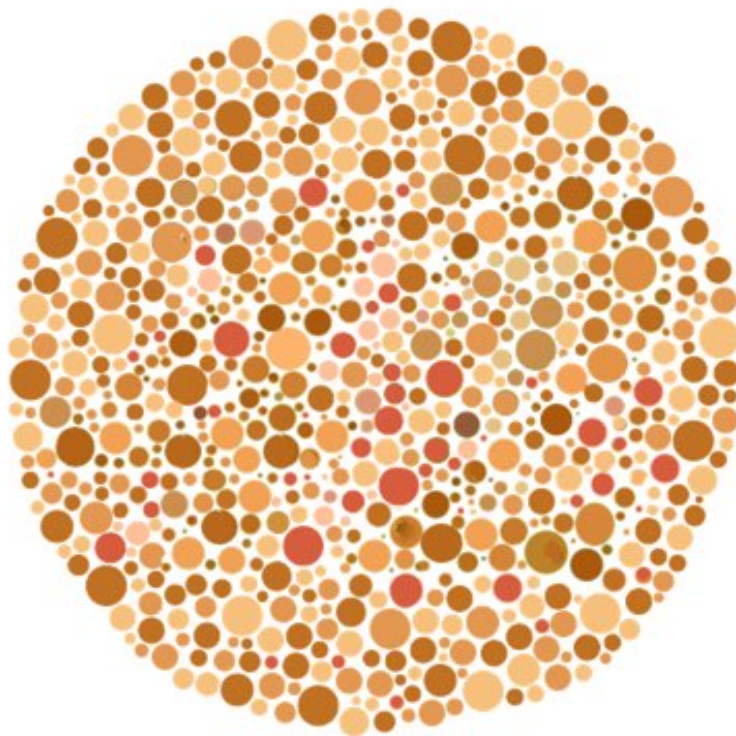
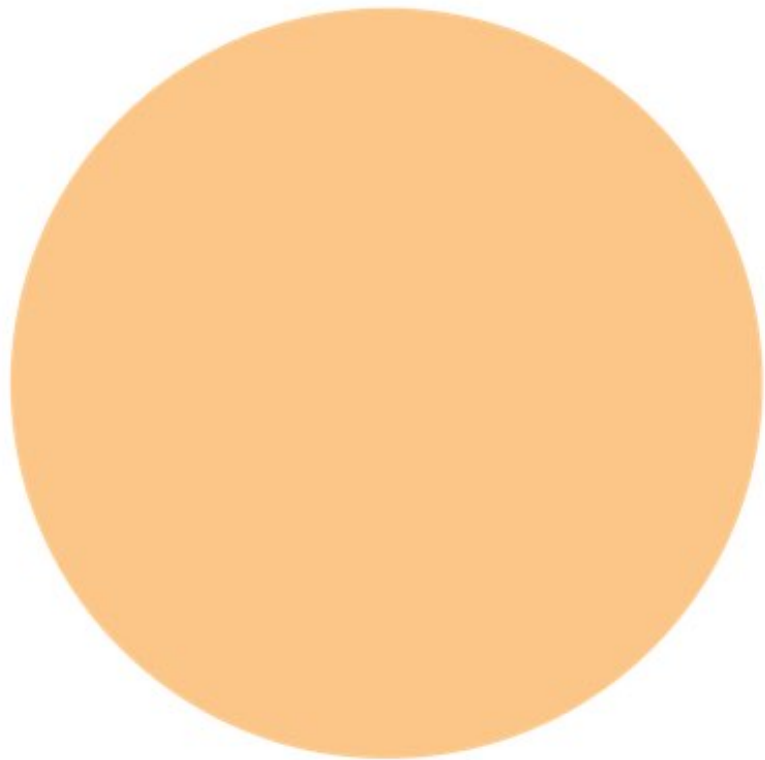

Tester



42



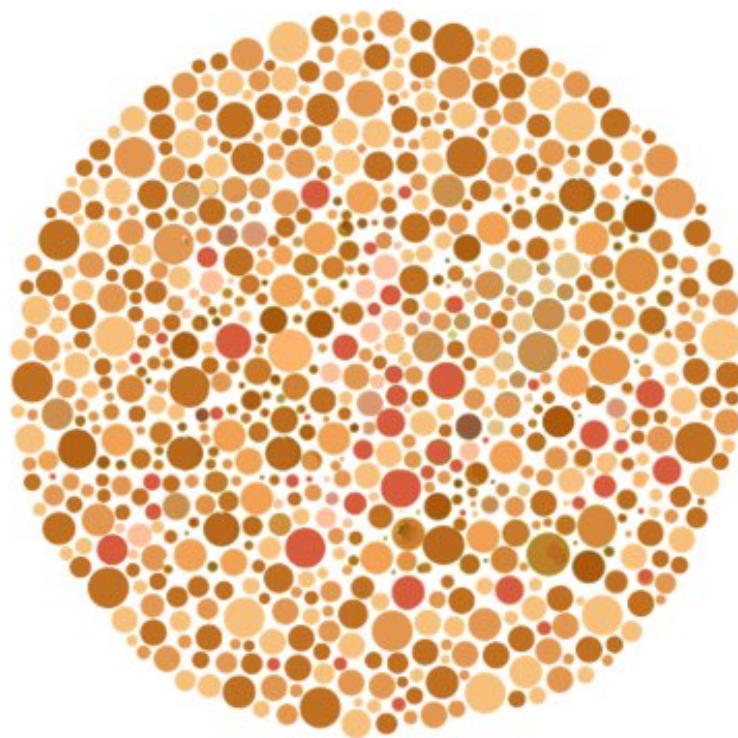
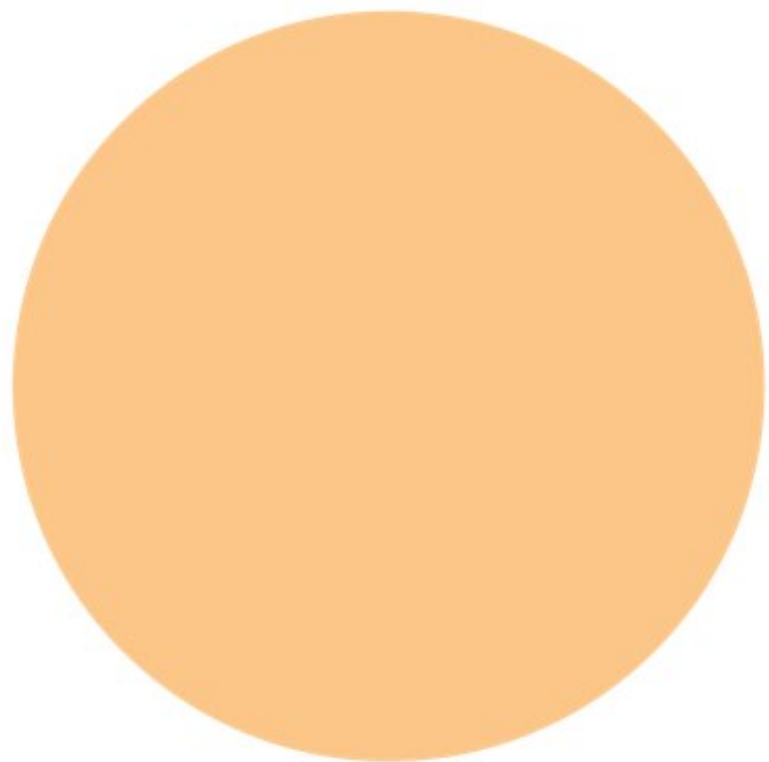

42



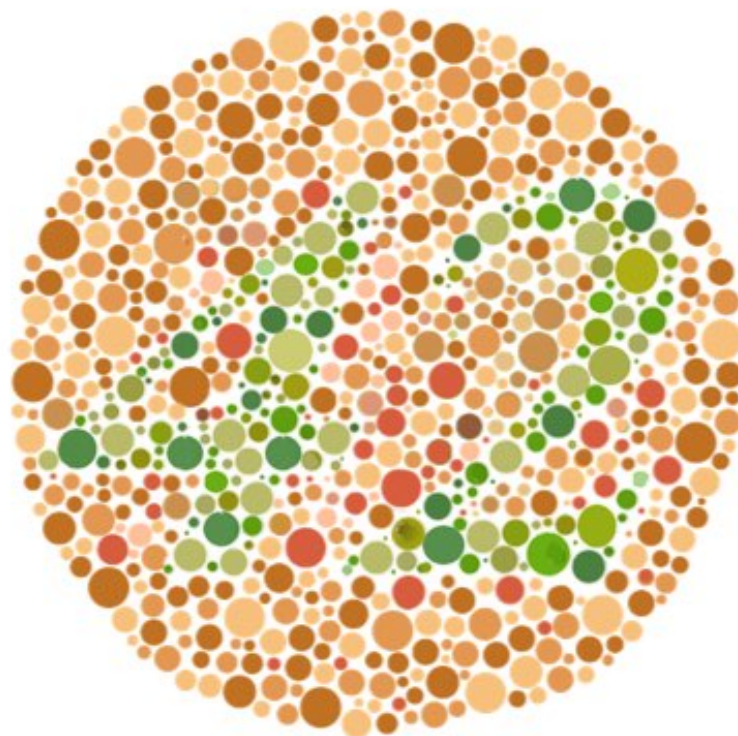



=

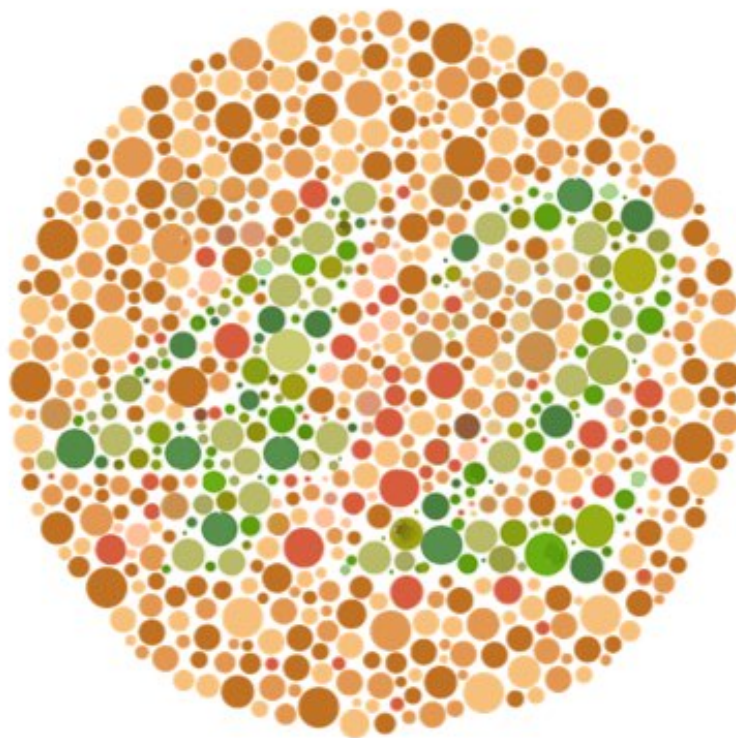

?

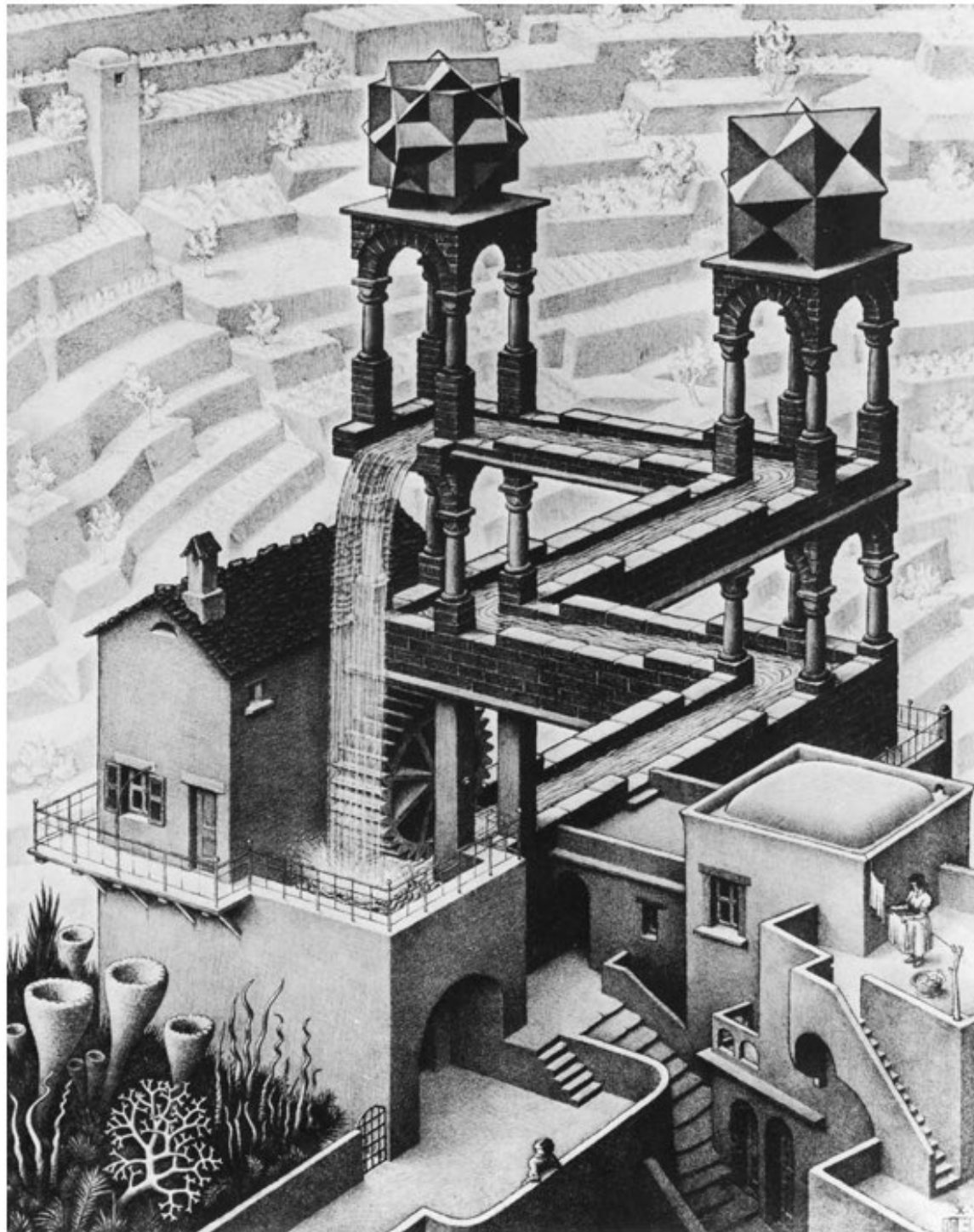

M.C. Escher Wasserfall (1961)



M.C. Escher Wasserfall (1961)

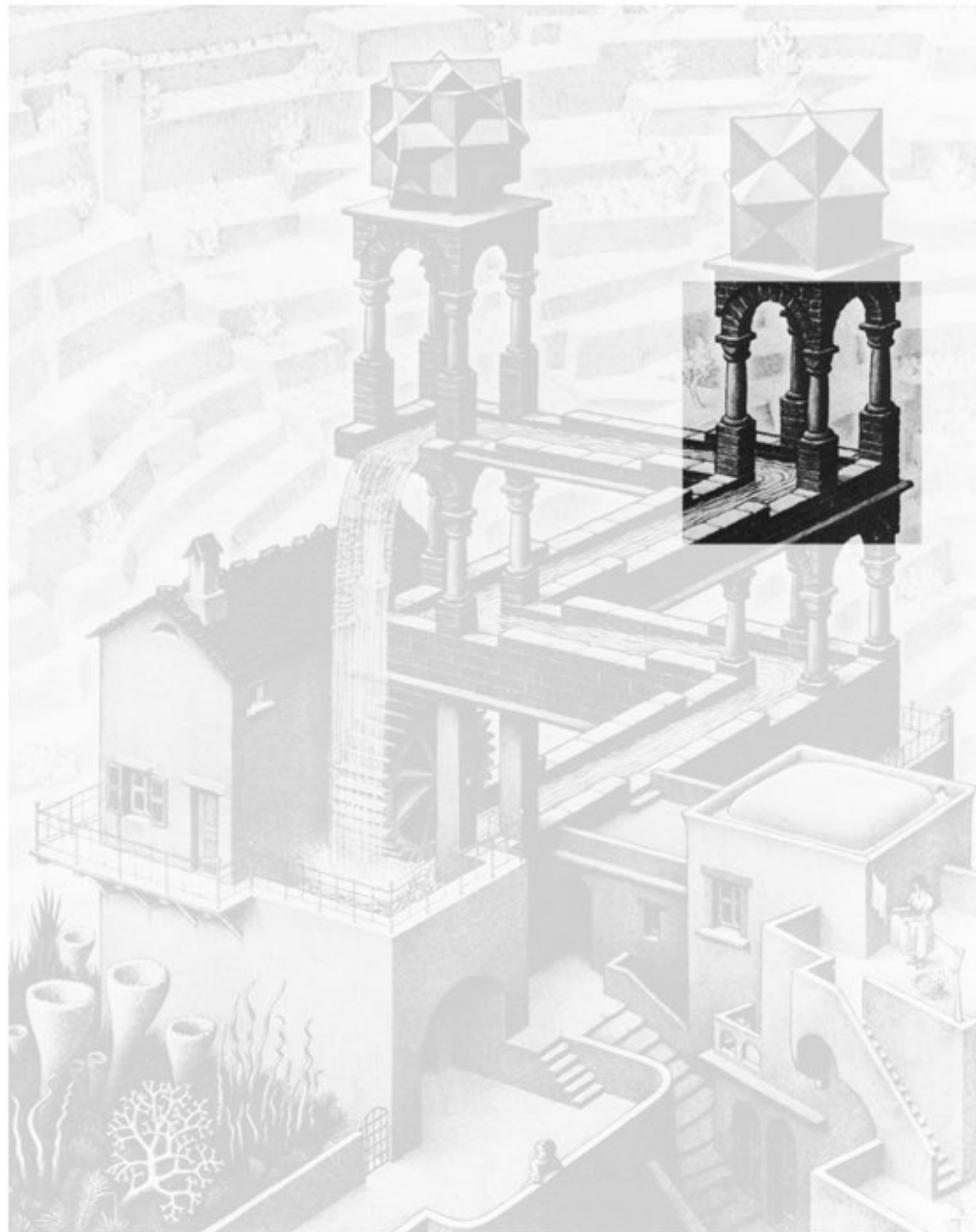

M.C. Escher Wasserfall (1961)



M.C. Escher Wasserfall (1961)



M.C. Escher Wasserfall (1961)

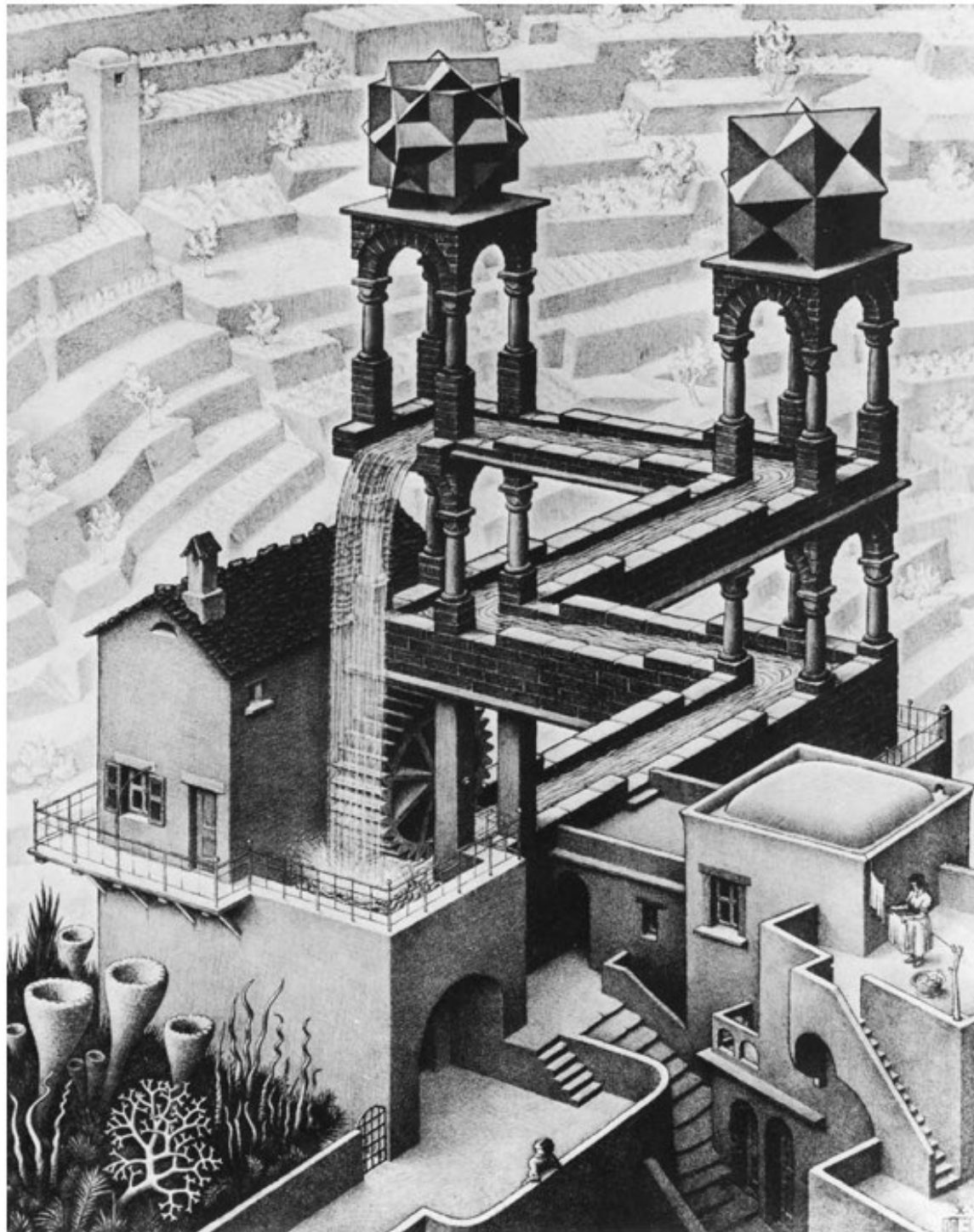

M.C. Escher Wasserfall (1961)

Alignment and Integration

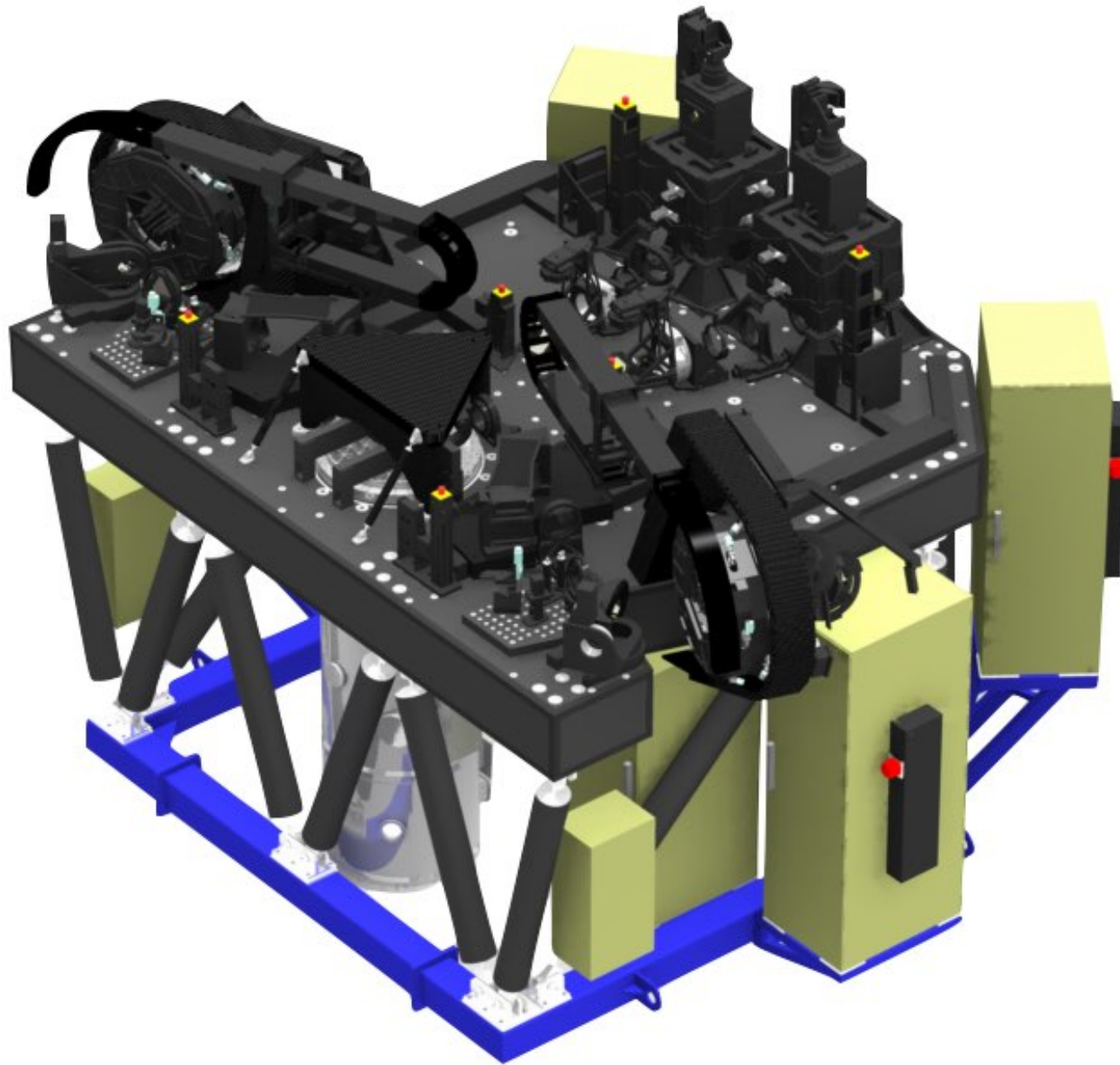

Alignment and Integration

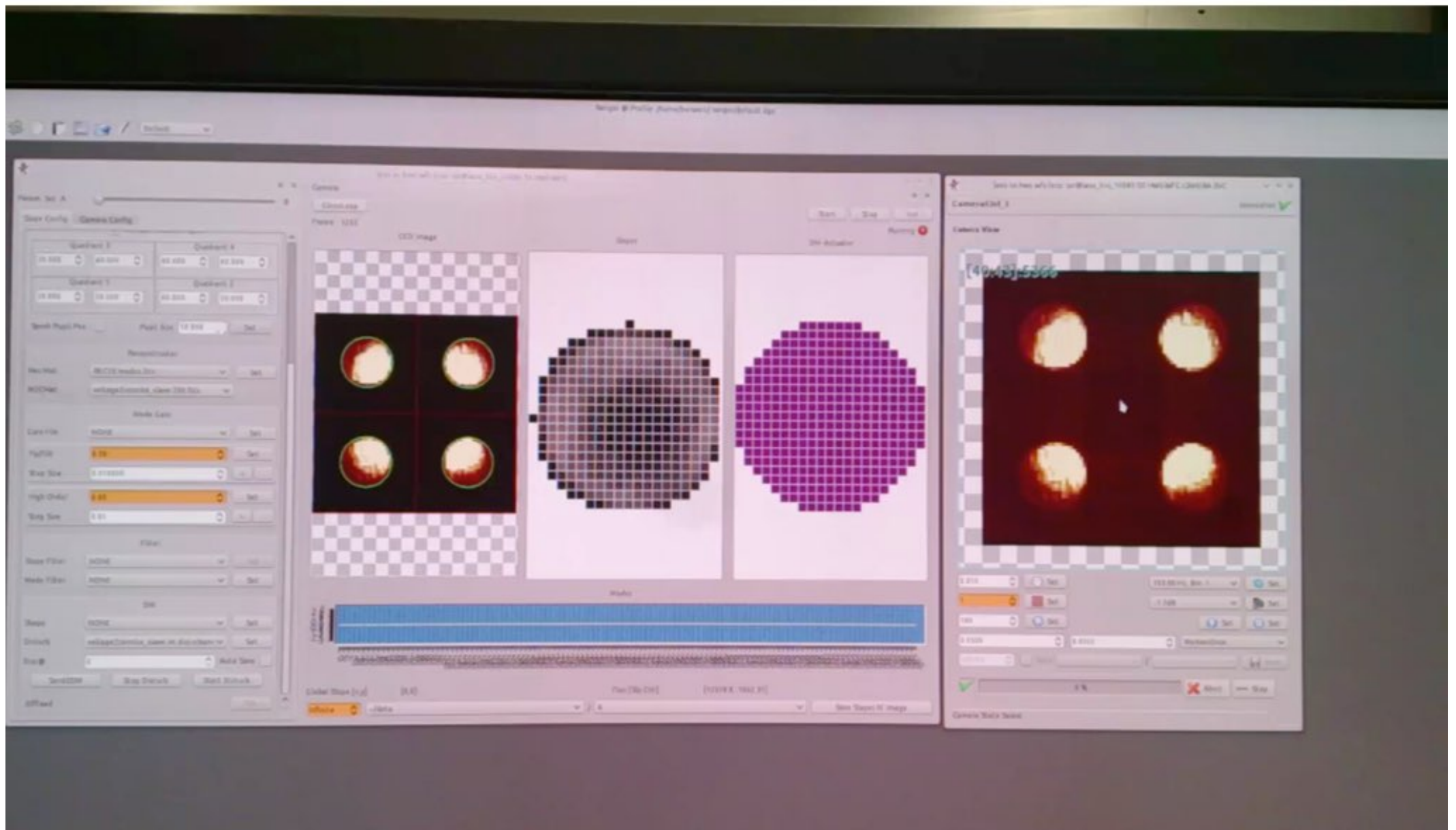

Monit Service Manager

Monit is running on lsys with *uptime, 9d 17h 53m* and monitoring:

System	Status	Load	CPU	Memory	Swap
<u>lsys</u>	Running	[0.72] [0.69] [0.71]	0.0%us, 0.0%sy, 0.1%wa	2.8% [897.5 MB]	0.0% [0.0 B]

Process	Status	Action	Log	Uptime	CPU Total	Memory Total
---------	--------	--------	-----	--------	-----------	--------------

lsys.cab		<input type="button" value="Start"/> <input type="button" value="Stop"/> <input type="button" value="Restart"/>				
<u>lsys.cab.cc.svr</u>	Running	<input type="button" value="Start"/> <input type="button" value="Stop"/> <input type="button" value="Restart"/>	Log	3d 18h 1m	0.0%	0.2% [69.4 MB]
<u>lsys.cab.ps.svr</u>	Running	<input type="button" value="Start"/> <input type="button" value="Stop"/> <input type="button" value="Restart"/>	Log	2d 3h 23m	0.0%	0.2% [82.1 MB]
<u>lsys.cab.int-svr</u>	Running	<input type="button" value="Start"/> <input type="button" value="Stop"/> <input type="button" value="Restart"/>	Log	6d 0h 37m	0.0%	0.2% [65.7 MB]

lsys.cryo		<input type="button" value="Start"/> <input type="button" value="Stop"/> <input type="button" value="Restart"/>				
<u>lsys.cryo-srv</u>	Running	<input type="button" value="Start"/> <input type="button" value="Stop"/> <input type="button" value="Restart"/>	Log	-	-	-

lircs.moe.b-dx		<input type="button" value="Start"/> <input type="button" value="Stop"/> <input type="button" value="Restart"/>				
<u>lircs.moe.drot.b-dx</u>	Running	<input type="button" value="Start"/> <input type="button" value="Stop"/> <input type="button" value="Restart"/>	Log	-	-	-
<u>lircs.moe.smc.b-dx</u>	Running	<input type="button" value="Start"/> <input type="button" value="Stop"/> <input type="button" value="Restart"/>	Log	-	-	-
<u>lircs.moe.dpos.b-dx</u>	Running	<input type="button" value="Start"/> <input type="button" value="Stop"/> <input type="button" value="Restart"/>	Log	-	-	-
<u>lircs.moe.dwr.b-dx</u>	Running	<input type="button" value="Start"/> <input type="button" value="Stop"/> <input type="button" value="Restart"/>	Log	-	-	-
<u>lircs.moe.fwr.b-dx</u>	Running	<input type="button" value="Start"/> <input type="button" value="Stop"/> <input type="button" value="Restart"/>	Log	-	-	-

lircs.moe.fwr.b-dx		<input type="button" value="Start"/> <input type="button" value="Stop"/> <input type="button" value="Restart"/>				
---------------------------	--	---	--	--	--	--

laos.dx.hws.moe.sensor-svr	Running	<input type="button" value="Start"/>	<input type="button" value="Stop"/>	<input type="button" value="Restart"/>	Log	-	-	-
laos.dx.hws.moe.calibrationUnits-svr	Running	<input type="button" value="Start"/>	<input type="button" value="Stop"/>	<input type="button" value="Restart"/>	Log	-	-	-
laos.dx.hws.drot.derotation-svr	Running	<input type="button" value="Start"/>	<input type="button" value="Stop"/>	<input type="button" value="Restart"/>	Log	-	-	-
laos.dx.hws.wfc.xinetics-svr	Running	<input type="button" value="Start"/>	<input type="button" value="Stop"/>	<input type="button" value="Restart"/>	Log	-	-	-

laos.sx.gws		<input type="button" value="Start"/>	<input type="button" value="Stop"/>	<input type="button" value="Restart"/>				
laos.sx.gws.wfc.loop-svr	Running	<input type="button" value="Start"/>	<input type="button" value="Stop"/>	<input type="button" value="Restart"/>	Log	-	-	-
laos.sx.gws.se.starEnlarger-svr	Running	<input type="button" value="Start"/>	<input type="button" value="Stop"/>	<input type="button" value="Restart"/>	Log	-	-	-
laos.sx.gws.moe.sensor-svr	Running	<input type="button" value="Start"/>	<input type="button" value="Stop"/>	<input type="button" value="Restart"/>	Log	-	-	-
laos.sx.gws.moe.annularMirror-svr	Running	<input type="button" value="Start"/>	<input type="button" value="Stop"/>	<input type="button" value="Restart"/>	Log	-	-	-
laos.sx.gws.drot.derotation-svr	Running	<input type="button" value="Start"/>	<input type="button" value="Stop"/>	<input type="button" value="Restart"/>	Log	-	-	-

laos.sx.hws		<input type="button" value="Start"/>	<input type="button" value="Stop"/>	<input type="button" value="Restart"/>				
laos.sx.hws.wfc.loop-svr	Running	<input type="button" value="Start"/>	<input type="button" value="Stop"/>	<input type="button" value="Restart"/>	Log	-	-	-
laos.sx.hws.se.starEnlarger-svr	Running	<input type="button" value="Start"/>	<input type="button" value="Stop"/>	<input type="button" value="Restart"/>	Log	-	-	-
laos.sx.hws.pcam.ccd47-svr	Running	<input type="button" value="Start"/>	<input type="button" value="Stop"/>	<input type="button" value="Restart"/>	Log	-	-	-
laos.sx.hws.moe.warmOptics-svr	Running	<input type="button" value="Start"/>	<input type="button" value="Stop"/>	<input type="button" value="Restart"/>	Log	-	-	-
laos.sx.hws.moe.sensor-svr	Running	<input type="button" value="Start"/>	<input type="button" value="Stop"/>	<input type="button" value="Restart"/>	Log	-	-	-
laos.sx.hws.moe.calibrationUnits-svr	Running	<input type="button" value="Start"/>	<input type="button" value="Stop"/>	<input type="button" value="Restart"/>	Log	-	-	-
laos.sx.hws.drot.derotation-svr	Running	<input type="button" value="Start"/>	<input type="button" value="Stop"/>	<input type="button" value="Restart"/>	Log	-	-	-
laos.sx.hws.wfc.xinetics-svr	Running	<input type="button" value="Start"/>	<input type="button" value="Stop"/>	<input type="button" value="Restart"/>	Log	-	-	-

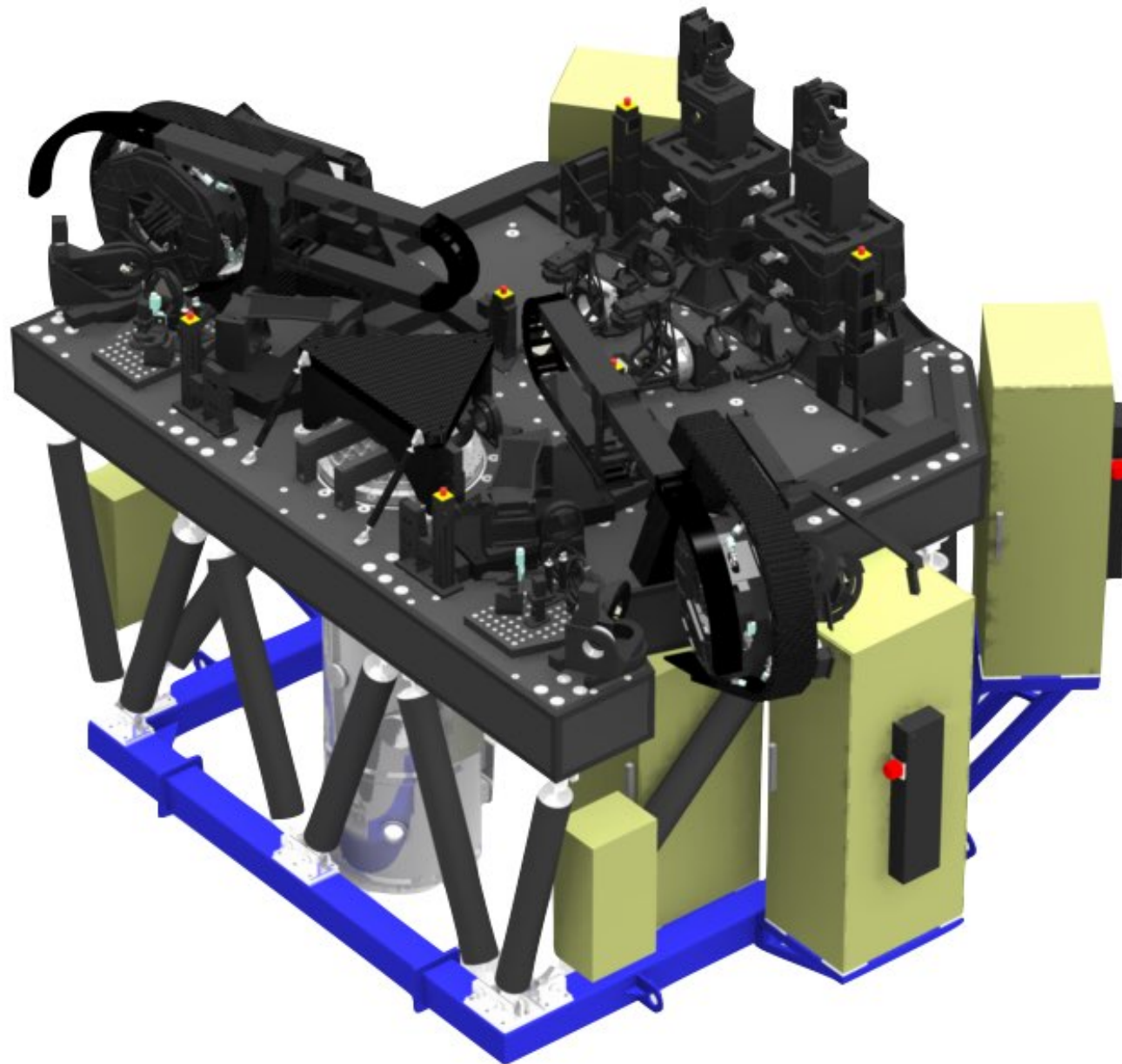

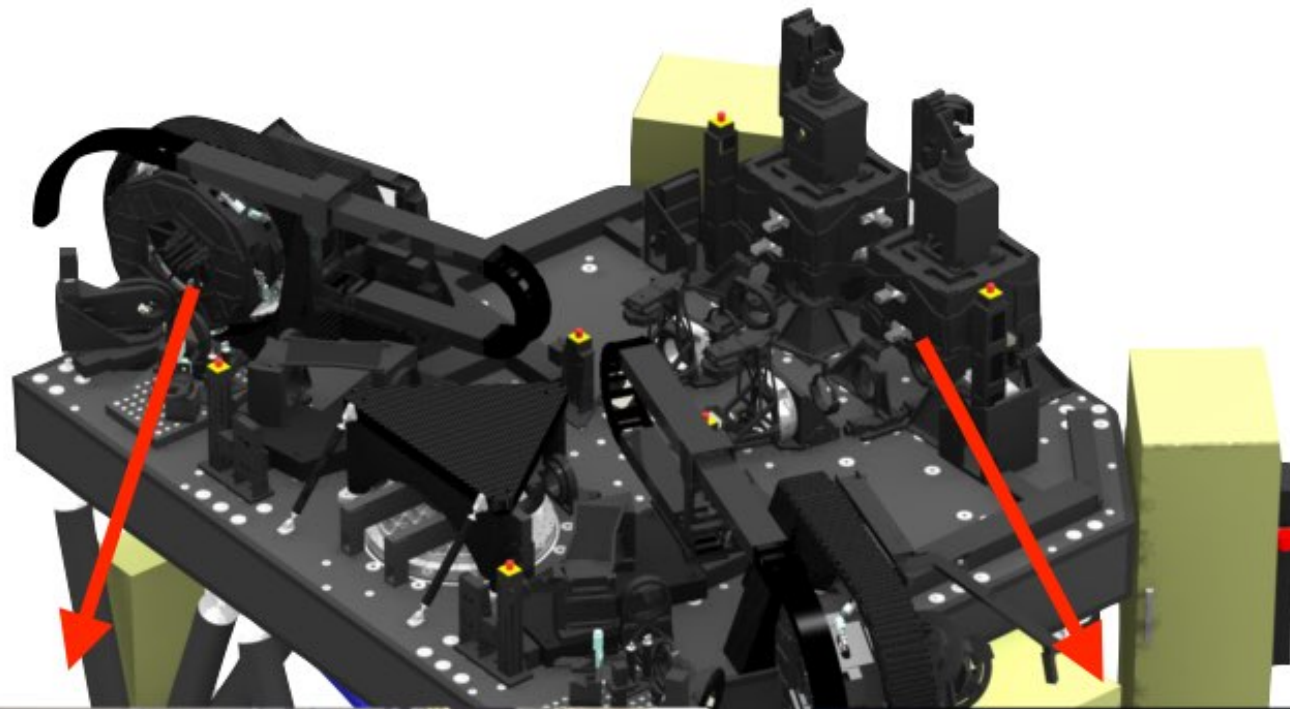

GWS

HWS

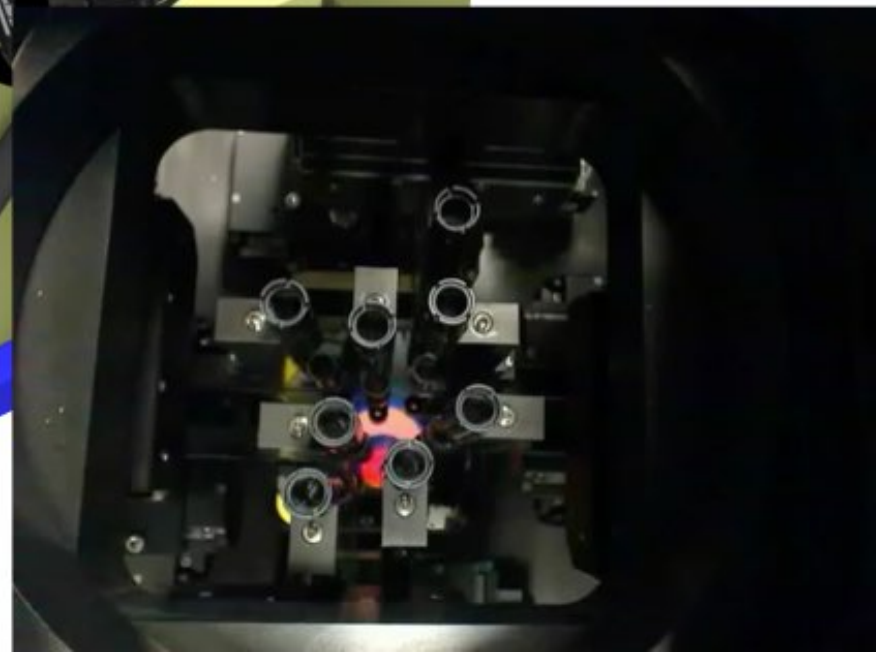
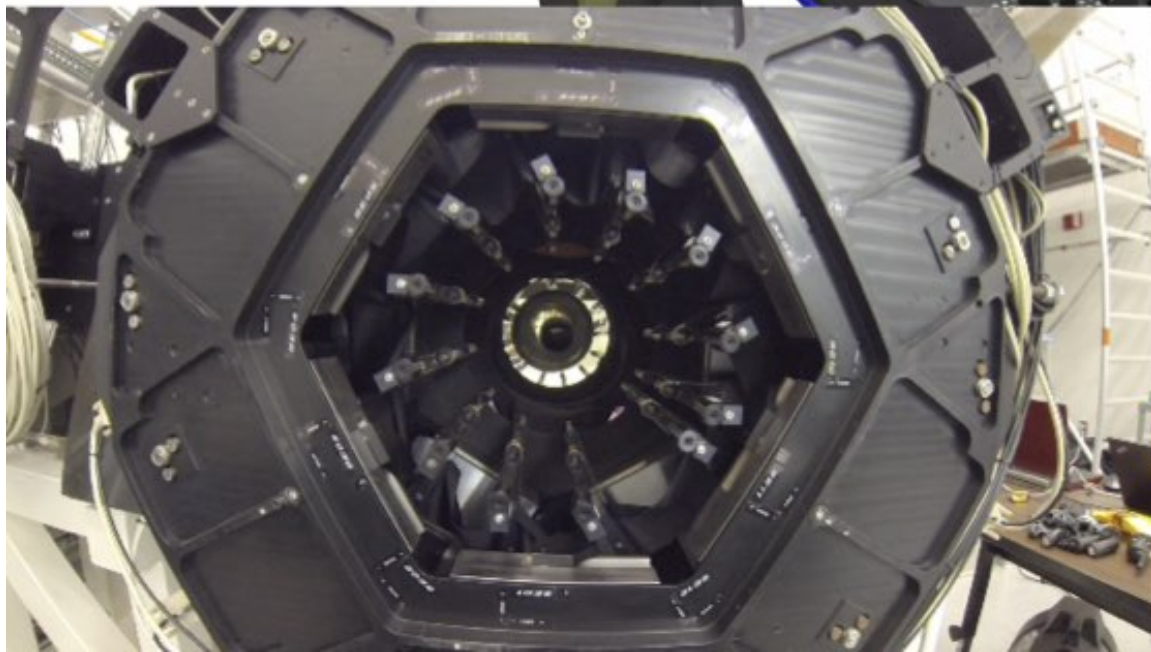

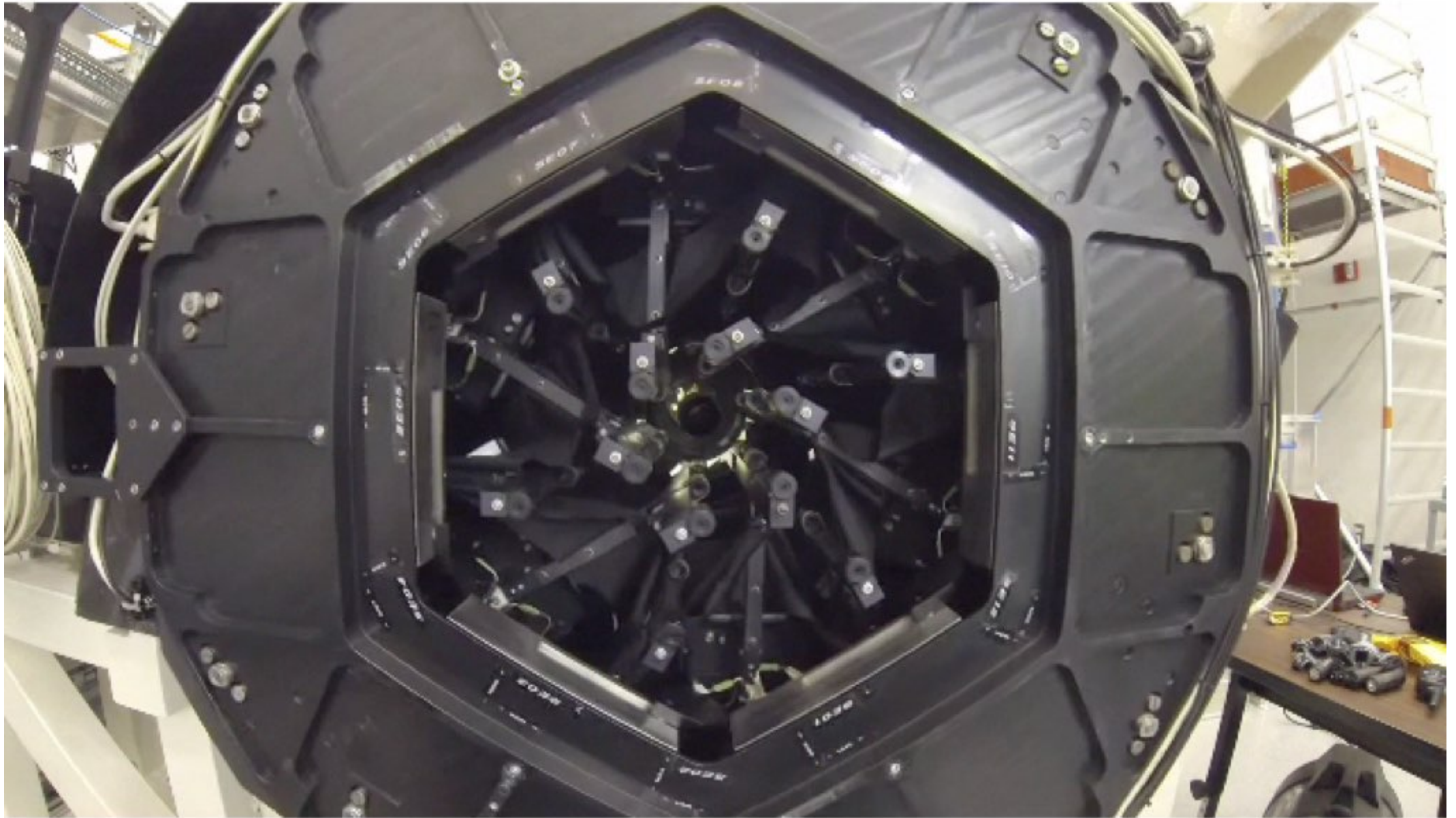

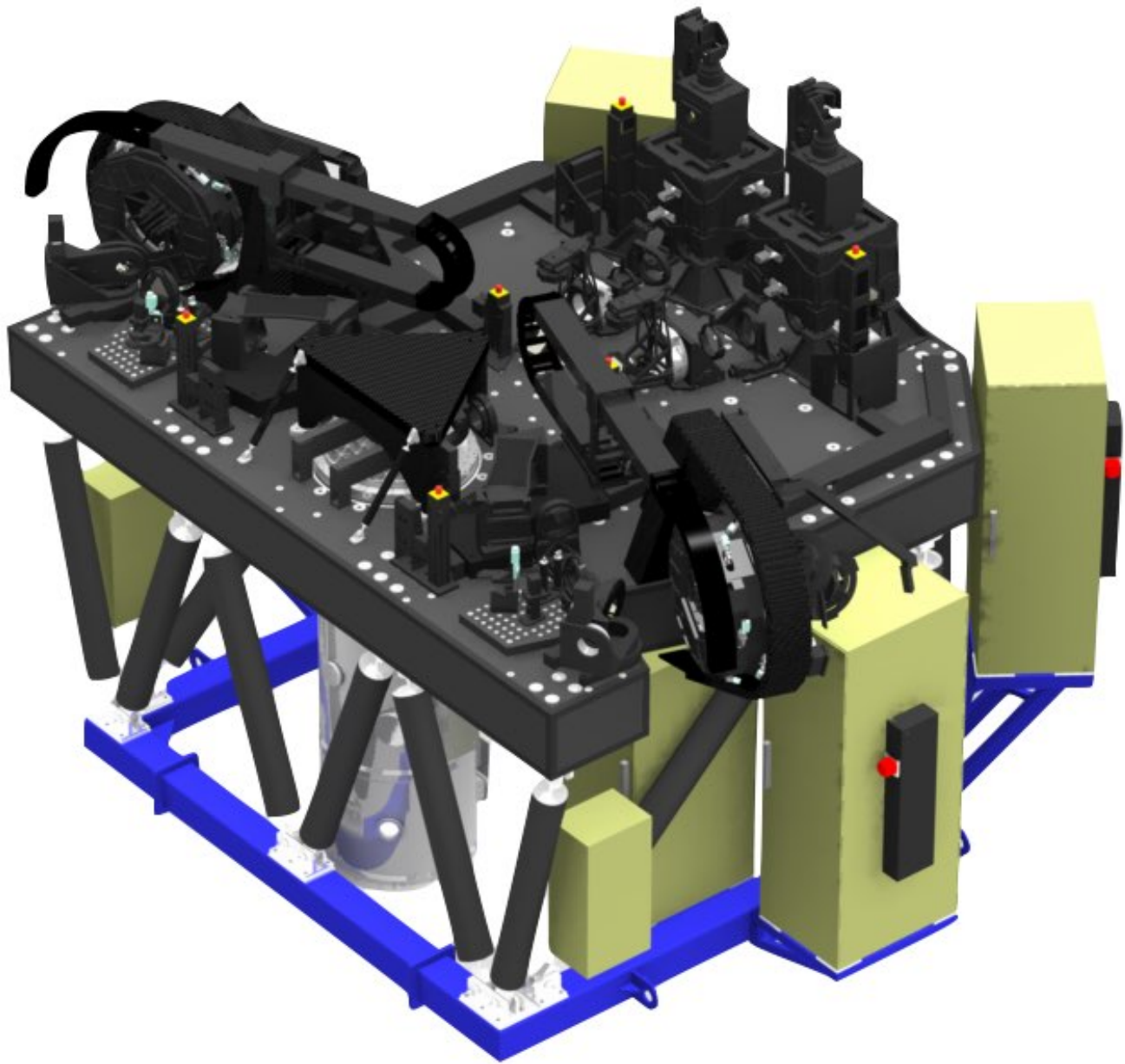

WFS

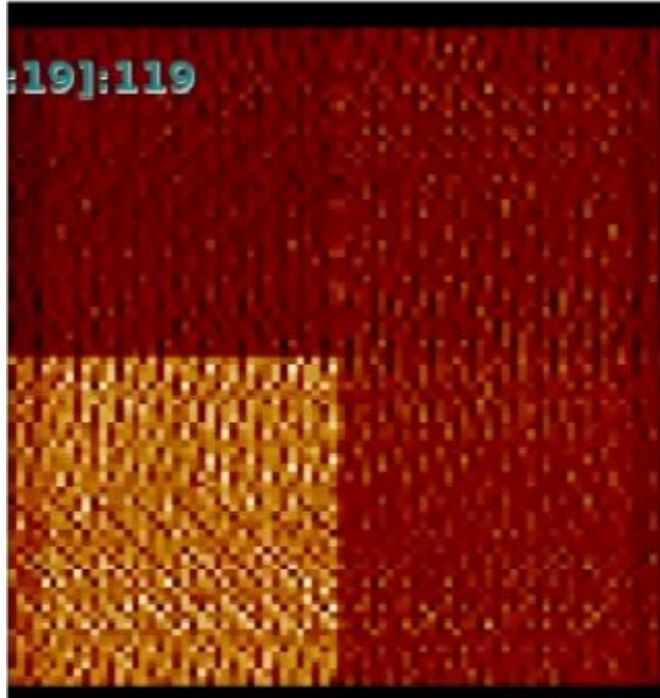

Fibers

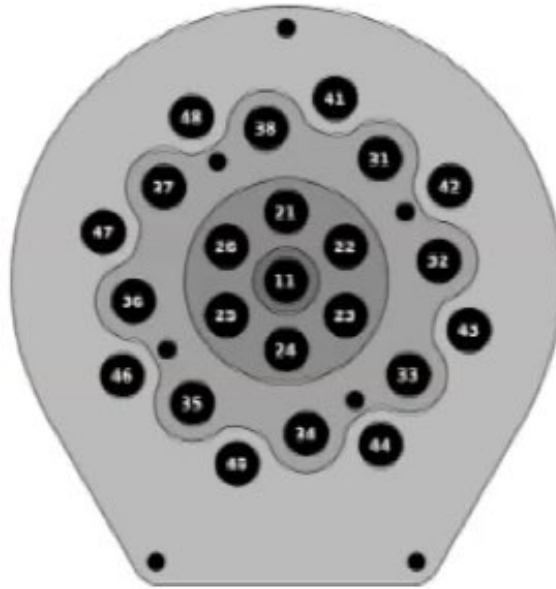

Star Probes

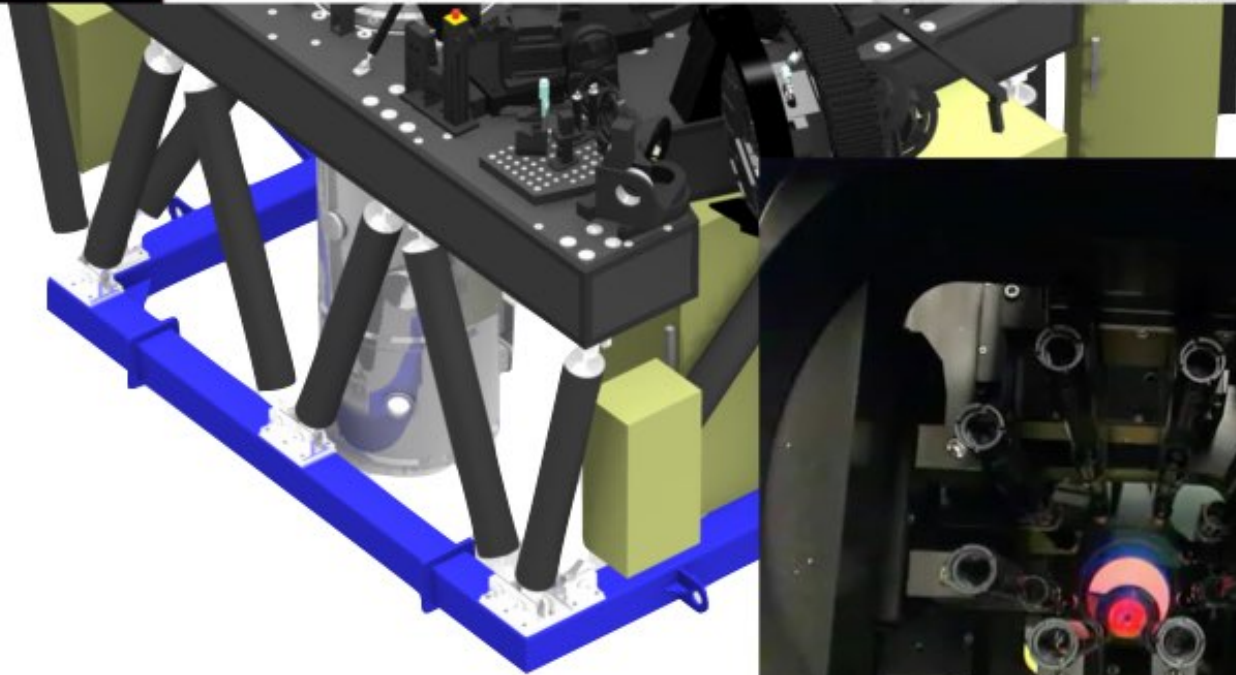
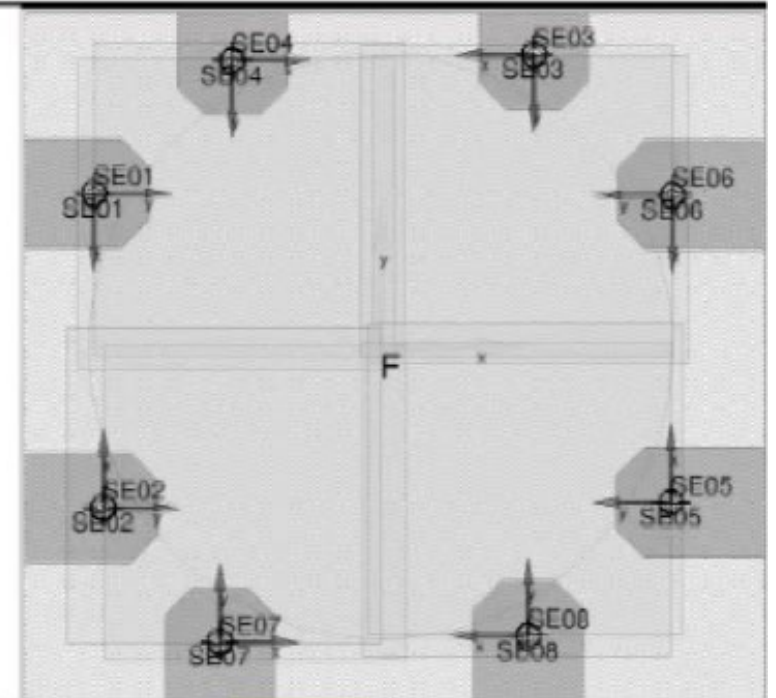

HWS

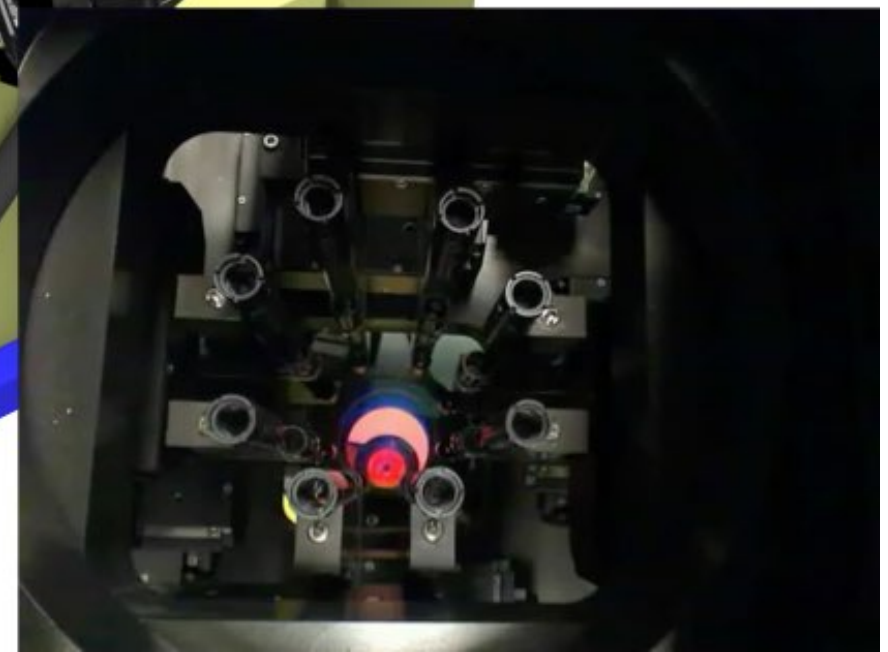

WFS

Fibers

Star Probes

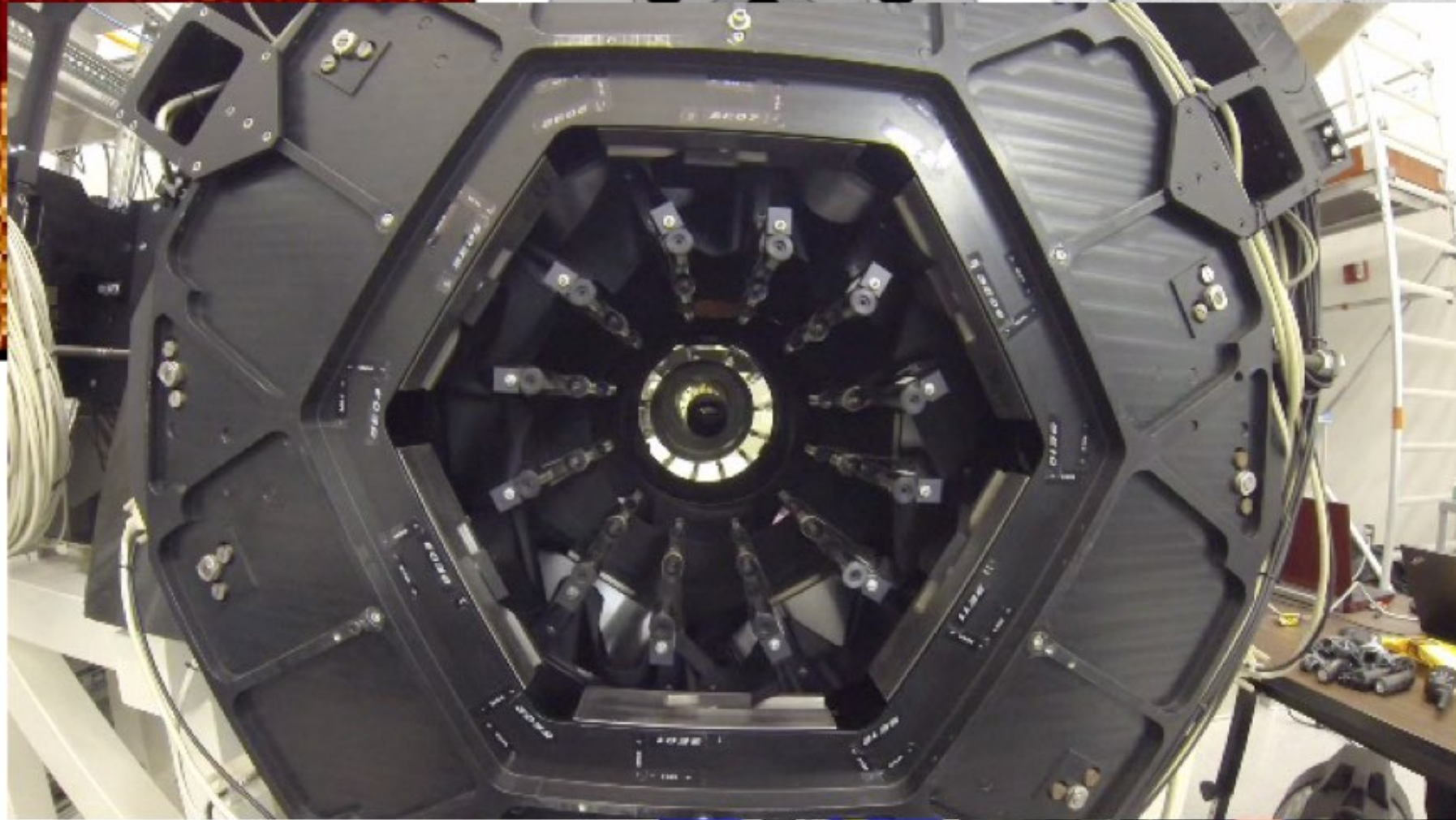

HWS



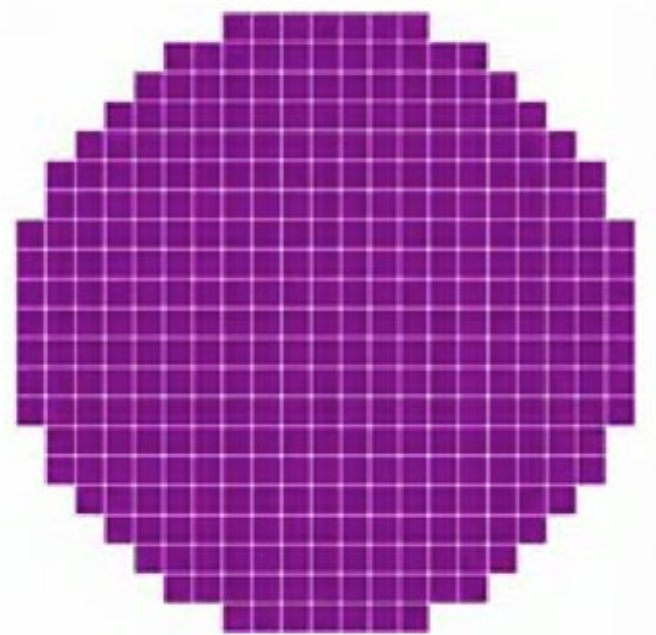
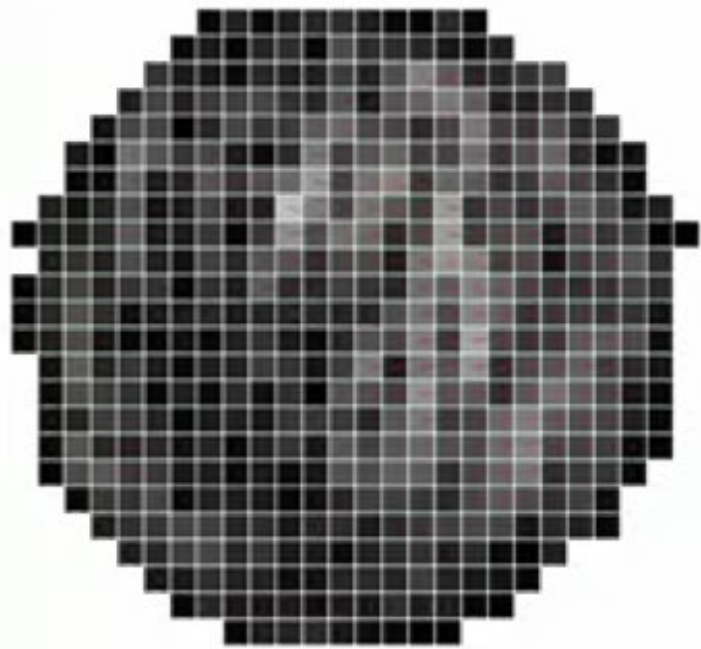
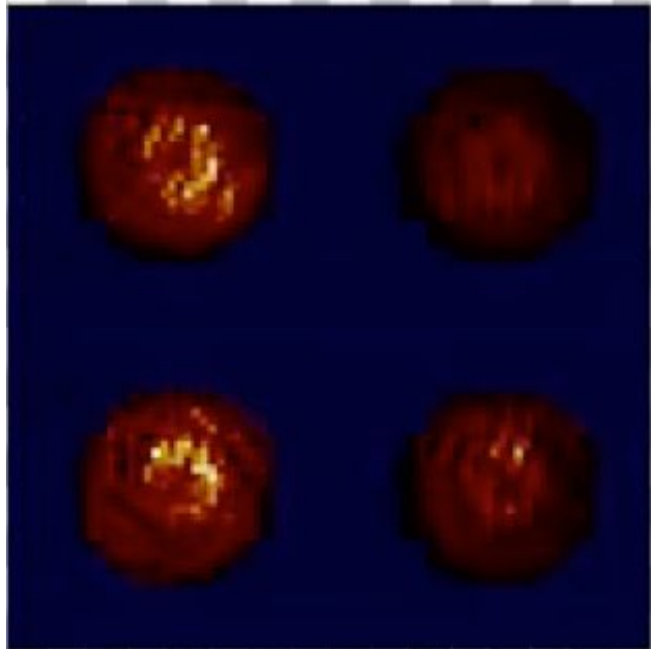

Open Loop

Close Loop

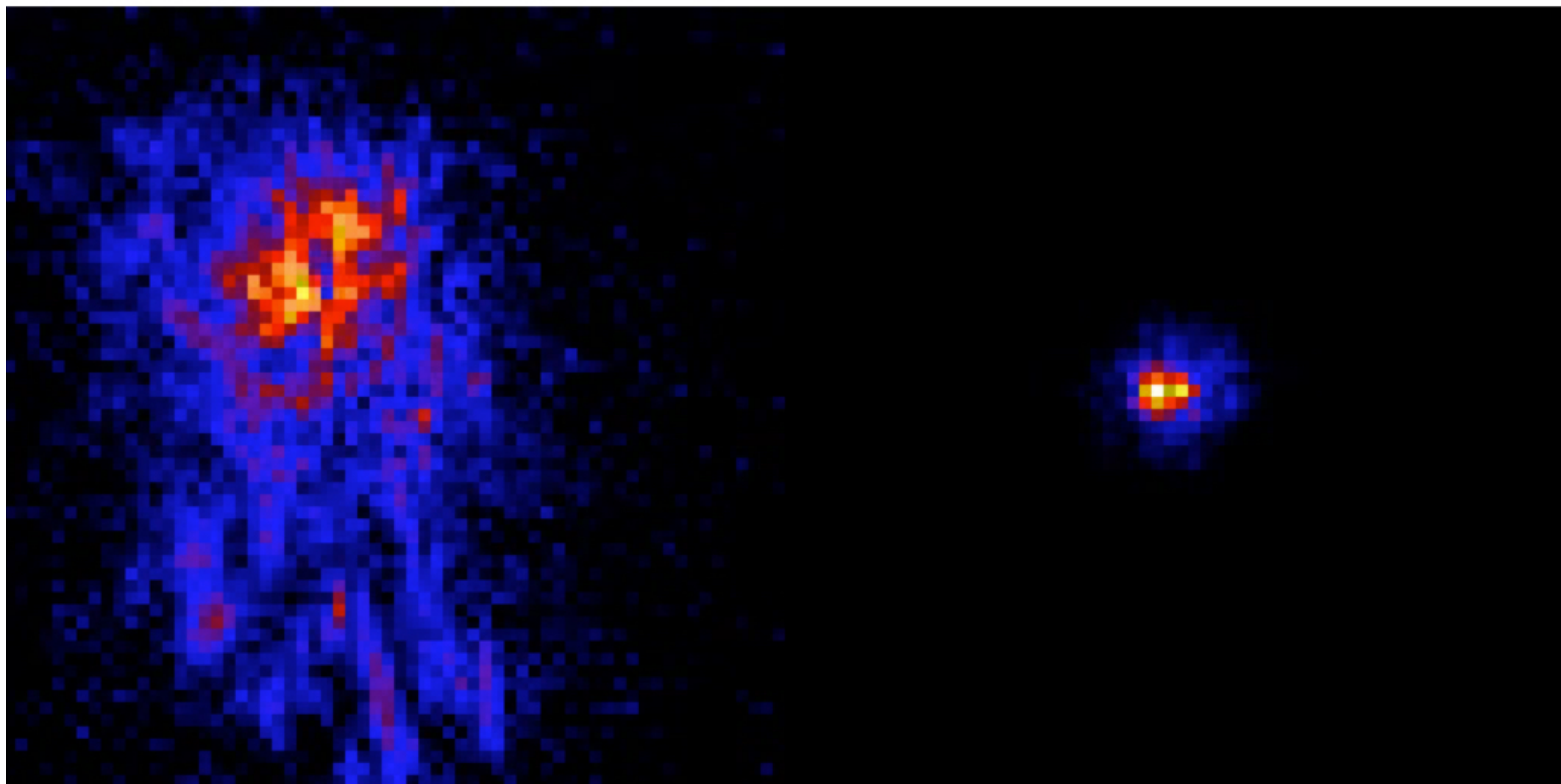



Modal Amplitude

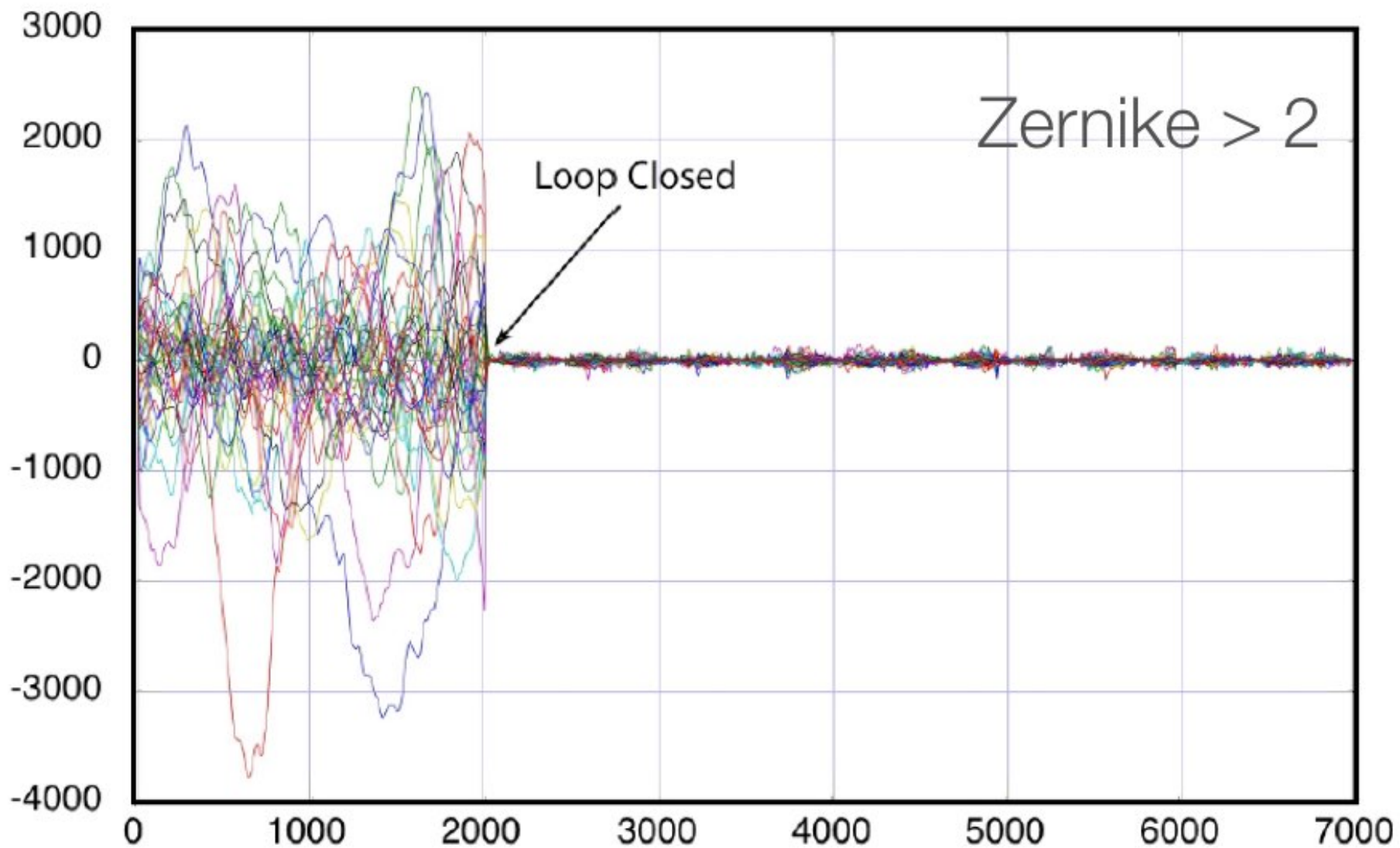

Loop Closed

Zernike > 2

Frame Count

Next Steps

Summer 2016 * complete I6 - I10 reintegration

Sept 2016 * install and align on telescope

Oct 2016 * begin commissioning

Early 2017 * begin Early Science

Conclusion

- * The team needs to work on the Instrument description together (Kickoff Meeting / PDR / FDR)
- * Common software (like TwiceAsNice) prevent to invent the wheel every time again but needs maintenance
- * Official software test has to taken into account

Exit 0

